

# RADION 8140

## USER GUIDE

Automatic sprayer control  
98-01467 R6



**TeeJet**<sup>®</sup>  
TECHNOLOGIES

A Subsidiary of  Spraying Systems Co.<sup>®</sup>



### **Safety information**

TeeJet Technologies is not responsible for damage or physical harm caused by failure to adhere to the following safety requirements. As the operator of the vehicle, you are responsible for its safe operation. The Radion 8140 in combination with any assisted/auto steering device is not designed to replace the vehicle's operator. Do not leave a vehicle while the Radion 8140 is engaged. Ensure the area around the vehicle is clear of people and obstacles before and during engagement. The Radion 8140 is designed to support and improve efficiency while working in the field. The driver has full responsibility for the quality and work related results. Disengage or remove any assisted/auto steering device before operating on public roads.

## Table of contents

<b>NO.1 POWER ON, SWITCHES</b>	<b>1</b>
Boom sections and switches .....	2
<b>NO.2 OPERATION SCREEN</b>	<b>3</b>
Operation menu.....	3
Information bar .....	4
Regulation modes .....	4
<b>NO. 3 GO TO HOME</b>	<b>5</b>
<b>1) SET UP THE LOCAL CULTURAL SETTINGS</b>	<b>5</b>
Establish preset target application rates .....	5
<b>3) SET UP THE MACHINE</b>	<b>6</b>
Operation .....	6
Implement parameters.....	7
Section configuration.....	7
Nozzle preset setup .....	7
Establish nozzle presets.....	8
Calibrations.....	8
<b>NO. 4 START NEW JOB OR CONTINUE JOB</b>	<b>10</b>
Jobs.....	10
<b>SENSOR CALIBRATIONS</b>	<b>11</b>
Implement speed sensor .....	11
Flow sensor.....	11
Liquid pressure sensor .....	12
Fill flow sensor .....	14
Tank level sensor .....	15
<b>OPERATION SCREEN</b>	<b>18</b>
<b>INFORMATION BAR</b>	<b>18</b>
Selectable information .....	18
Application rate.....	19
Select target application rate .....	19
Target rate percentage increase/decrease .....	20
Change application rate step.....	20
<b>NOZZLE SELECTION</b>	<b>21</b>
Selecting the current nozzle .....	21
Presetting nozzles.....	21
<b>TANK</b>	<b>22</b>

# Radion 8140 automatic sprayer control

---

ALARM WARNING

22

PRESSURE GAUGE

23

USER SETTING NOTES

24

---

ALARM CONFIGURATIONS

26

---

UNIT SPECIFICATIONS

27

---

# Radion 8140 automatic sprayer control

## NO.1 POWER ON, SWITCHES

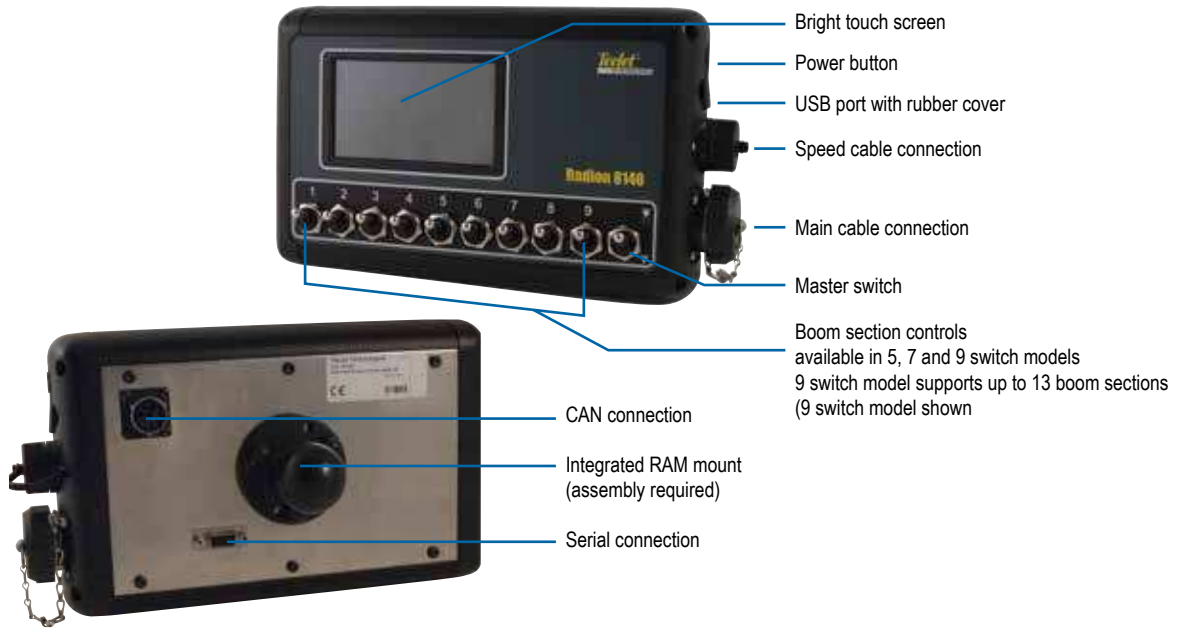

### Power on/off button

On – Press the POWER button  to power on the console. Upon power up, the Radion will begin its start up sequence. Once start up is complete, the Operation screen appears.

Off – Press the POWER button . On the confirmation screen to acknowledge shut down mode, press **Yes** to power off the console.

**WARNING!** Wait 10 seconds before restarting the console.

### Simulated speed alert

An alert will sound at start-up if simulated speed is activated.

Figure 1: System diagram

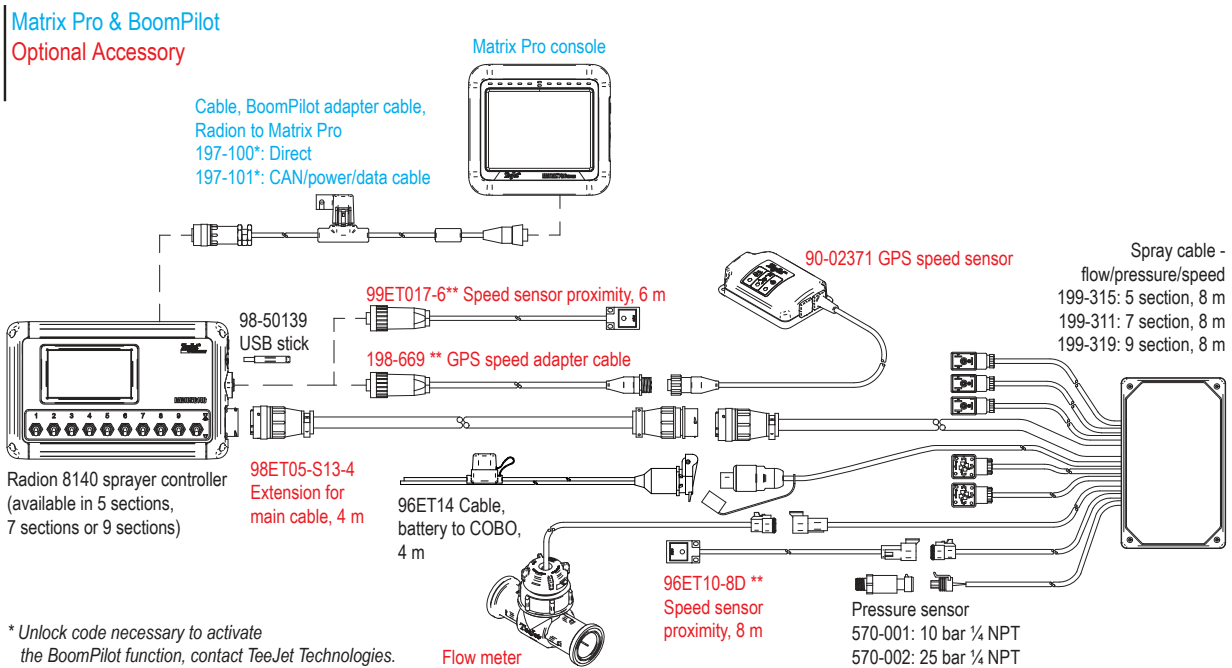

\* Unlock code necessary to activate the BoomPilot function, contact TeeJet Technologies.  
\*\* Only one speed source at the same time.

# Radion 8140 automatic sprayer control

## Boom sections and switches

The console operates with, nine (9), seven (7) or five (5) section switches (depending on console model) and one (1) Master switch. In the nine (9), seven (7) and five (5) section switch models, each section switch is associated with one of up to the same number of sections on the boom and illustrated on the Operation screen.

Nine (9) switch consoles are capable of supporting up to 13 boom sections. The boom sections are paired across the nine (9) switches evenly but will work as individual sections in ASC mode.

**NOTE:** Although the Number of sections range is up to 13, the max. number of physical switches are still nine (9).

- ▶ Switches – control individual boom sections
  - ◀ On – Flip the switch up
  - ◀ Off – Flip the switch down
- ▶ Master switch – opens/closes the main product valves and enables/disables power to individual boom section on/off switches
  - ◀ cannot be activated outside of the Operation screen
- ▶ Boom sections spray status – displays the status of the section switches in association to the master switch. Number of sections shown is established in Settings-> OEM->Implement parameters.
  - ◀ Section on, master switch on – spray is blue
  - ◀ Section off, master switch on – spray is white
  - ◀ Master switch off – spray not shown

Figure 2: Master switch, 9 section switches



Figure 3: Boom sections

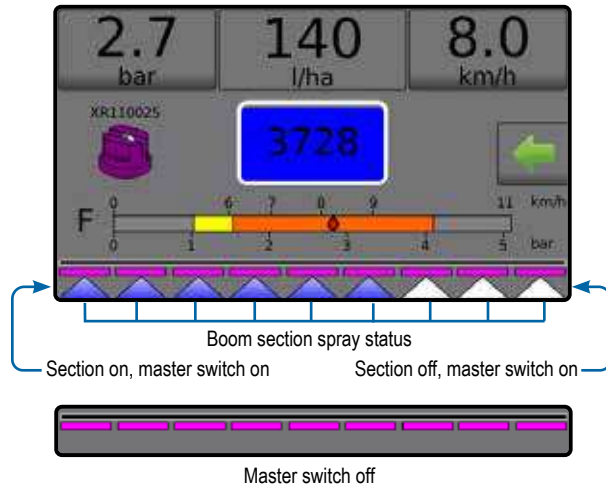
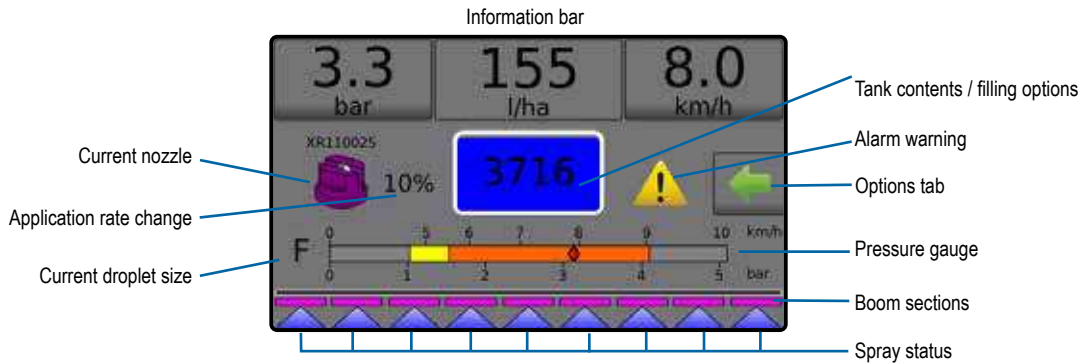

Table 1: Pairing key for 9 physical section switches operating with 10, 11, 12 and 13 boom sections

Section switches 1-9	Boom section pairing greater than 9 boom sections			
	10 sections	11 sections	12 sections	13 sections
1	1	1	1	1
2	2	2	2	2
3	3	3	3	3 and 4
4	4	4 and 5	4 and 5	5 and 6
5	5 and 6	6	6 and 7	7
6	7	7 and 8	8 and 9	8 and 9
7	8	9	10	10 and 11
8	9	10	11	12
9	10	11	12	13

**NOTE:** To make changes to the factory settings above, contact your local dealer or customer service representative for an OEM password.

## NO.2 OPERATION SCREEN



- ▶ Information bar – displays application rates and selectable information
- ▶ Current nozzle – displays current nozzle and accesses five (5) preset nozzle types
- ▶ Application rate change – displays rate changes (if in Automatic regulation mode)
- ▶ Tank – displays remaining tank contents and accesses filling options
  - ◀ Filling – establishes actual/desired tank material/density
- ▶ Alarm warning – displays active alarm conditions
- ▶ Options tab ← – accesses the Operation menu
  - ◀ Displays Home button 🏠, Close Menu button →, regulation modes and target rate options
- ▶ Pressure gauge – displays current pressure range compared with recommended pressure range
  - ◀ Droplet size – displays selected droplet size
- ▶ Boom sections – displays configured boom sections
  - ◀ Spray status – displays active/inactive for section

### Operation menu

The Options tab is always available on the Operation screen. This tab accesses the Operation menu where the Home button, regulation modes and target rate options display.

#### Operation menu buttons

	Home
	Change between automatic/manual regulation modes
Automatic regulation mode	
	Target rate boost percent increase
	Target rate boost percent decrease
	Return to target rate
Manual regulation mode	
	Regulation valve manual open
	Regulation valve manual close
	Close menu

Figure 4: Options tab – Automatic mode

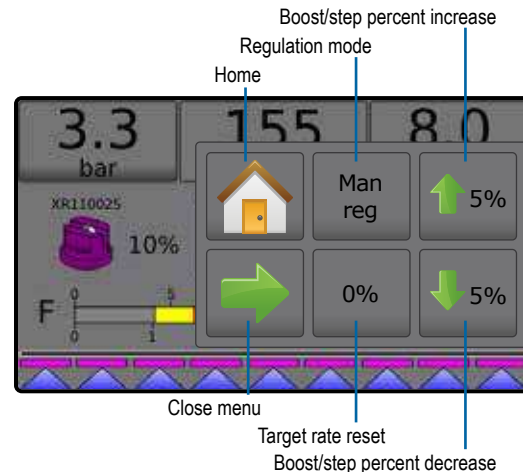
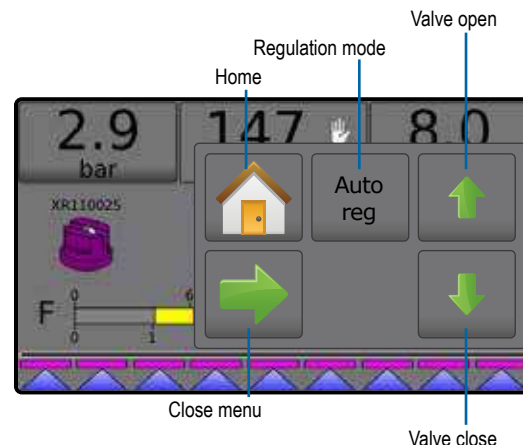

Figure 5: Options tab – Manual mode



# Radion 8140 automatic sprayer control

## Information bar

The information bar displays:

- ▶ Application rate – displays the actual application rate or target application rate and accesses the preset target application rates options menu.
- ▶ Selectable information – displays user-selected information including volume applied, flow rate, flow pressure, speed, total area applied and job number.

Figure 6: Information bar

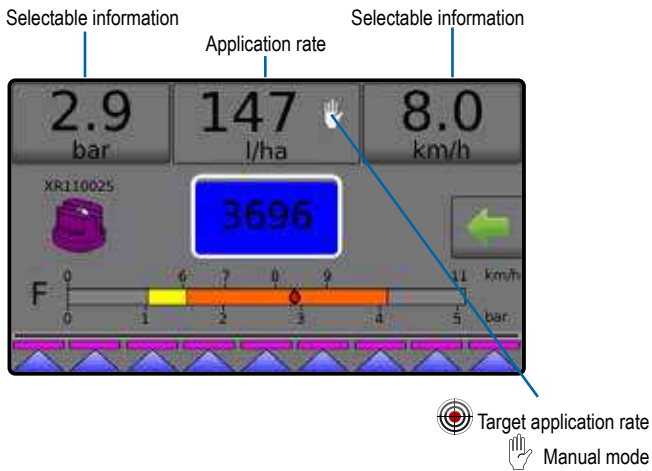
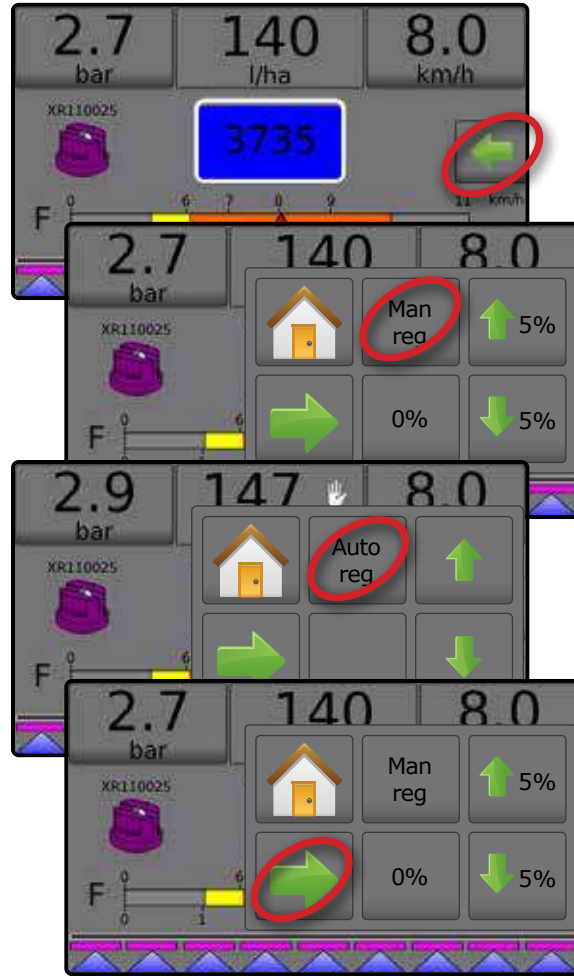

Figure 7: Regulation options: Automatic / Manual



## Regulation modes

Automatic regulation mode will automatically adjust the application rate based on the current speed in reference to the target rate. The target rate can be adjusted using the Boost/step percent increase/decrease buttons on the Operation menu. Preset application rates define up to three (3) target rates for product being applied per hectare/acre. These can be toggled using the Application rate section on the Information bar on the Operation screen.

Manual regulation mode will retain an established regulation valve setting regardless of speed. The regulation valve setting can be adjusted using the Regulation valve open/close buttons on the Operation menu.

1. From the Operation screen, press the OPTIONS tab to display the Operation menu.
2. Select from:
  - ▶ **Auto reg** to change from Manual regulation mode to Automatic regulation mode:
  - ▶ **Man reg** to change from Automatic regulation mode to Manual regulation mode:

NOTE: The Regulation button displays the regulation mode that may be selected not the active regulation mode.

## Manual regulation mode

Manual regulation mode will retain an established regulation valve setting regardless of speed.

To open/close the valve:

1. From the Operation screen, press the OPTIONS tab to display the Operation menu.
2. Press the Regulation valve open/close buttons to manually turn the valves on/off.
3. Press the Close menu button .

Figure 8: Manual regulation mode





## NO. 3 GO TO HOME

### 1) SET UP THE LOCAL CULTURAL SETTINGS

Cultural configures language, units, date and time settings.



- From the Home screen, press the CONSOLE button .
- Press **Cultural**.
- Select from:
  - ▶ Language – defines the system language
  - ▶ Units – defines the system measurements
  - ▶ Date – establishes the date
  - ▶ Time – establishes the time
- Press RETURN arrow  to return to the main Console settings screen.



Figure 9: Cultural options

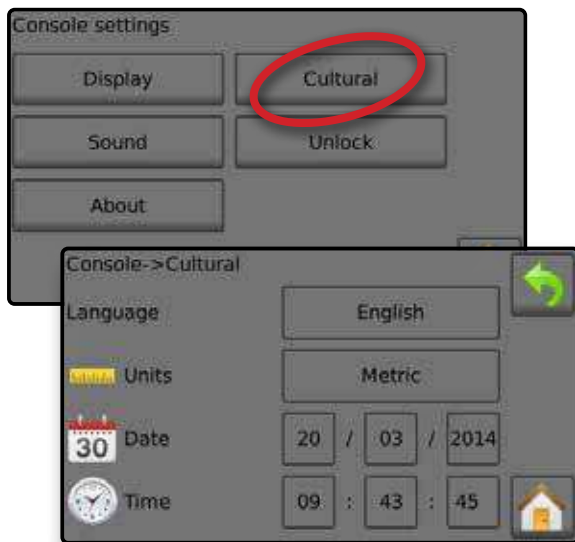

Code	Language
cs	Czech
de-DE	German
en-GB	English (international)
en-US	English (USA)
es-ES	Spanish (Europe)
es	Spanish (Central/South America)
fi	Finnish
fr-FR	French
hu	Hungarian
it-IT	Italian
nl	Dutch
pl	Polish
pt-BR	Portuguese (Brazil)
ru	Russian
sk	Slovak

NOTE: Droplet size classification is in accordance with ISO 25358 at the date of publication. Classifications are subject to change.

Job parameters configures the target application rate settings and current nozzle. Selections are also active on the Operation screen.

- From the Home screen, press the SETTINGS button .
- Press **Job parameters**.
- Press a setting value to adjust settings as needed.
  - ◀ Target application rate number – specifies up to three (3) target application rate presets from which to select
  - ◀ Target application rate – defines the target rate of product to apply for the selected number (these settings will be the same for all active jobs)
  - ◀ Nozzle type – selects the current nozzle type from the five (5) nozzle presets
  - ◀ Idle pressure – sets the minimum pressure when the master valve is off when using a non-circulation system and a Liquid pressure sensor is present
- Press the RETURN arrow  to return to the main Settings screen.

### 2) SET UP THE JOB PARAMETERS

Establish preset target application rates .

- From the Home screen, press the SETTINGS button .
- Press **Job parameters**.
- Select Application rate number 1 **1**.
- Select an application rate **2** to be associated with number 1.
- Repeat steps 3 and 4 for Application rate numbers 2 and 3.

Figure 10: Establish preset target application rate 2



# Radion 8140 automatic sprayer control

## 3) SET UP THE MACHINE

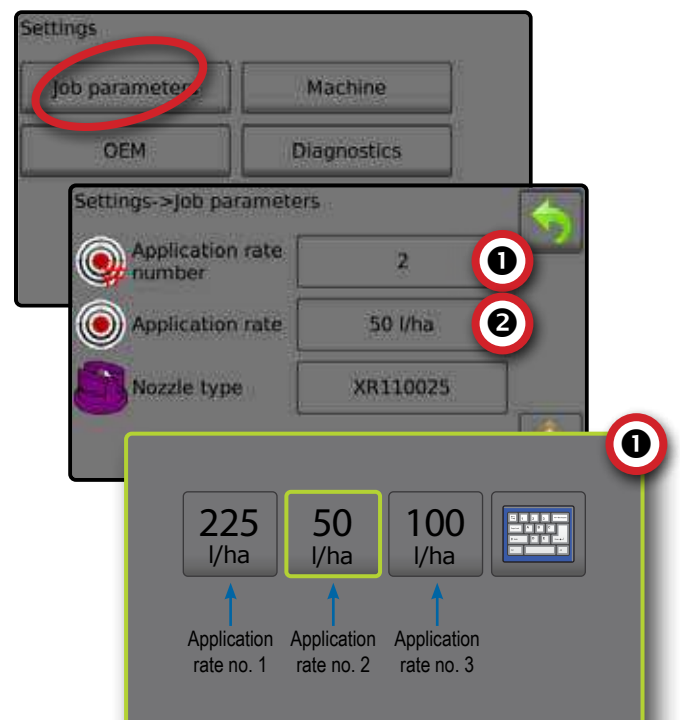
Machine configures machine settings. Options include Filling, Operation, Implement parameters, Calibrations and Alarms.



1. From the Home screen, press the SETTINGS button .
2. Press **Machine**.
3. Select from:
  - ▶ Filling – establishes the amount of actual and desired material in the tank and the density of that material
  - ▶ Operation – establishes application rate step, speed source, simulated speed and minimum speed
  - ▶ Implement parameters
    - ◀ Section configuration – sets the number of nozzles on the boom which determines the spraying width during application
    - ◀ Nozzle preset setup – establishes options for up to five (5) nozzles including series, capacity, low/high pressure limits, reference flow and reference pressure
    - ◀ Regulation parameters – adjusts valve calibration and nozzle spacing and selects a regulation mode
  - ▶ Calibrations – establishes either manual/automatic settings of the Implement speed sensor, Flow sensor, Liquid pressure sensor, Fill flow sensor and Tank level sensor
  - ▶ Alarms – establishes alarms on/off and sets their trigger levels
4. Press RETURN arrow  to return to the main Settings screen.

Figure 11: Machine



## Operation



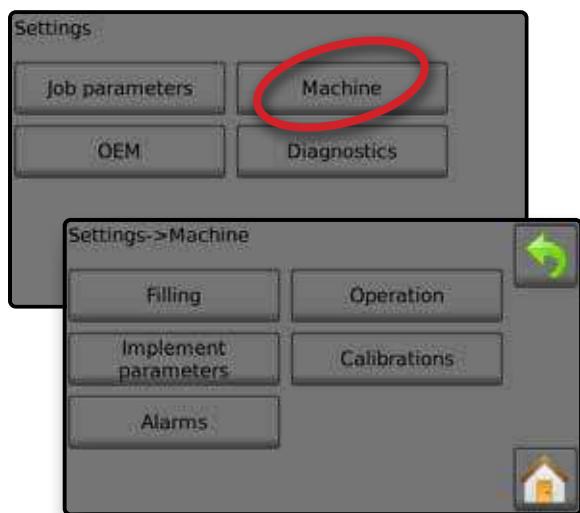

1. From the Home screen, press the SETTINGS button .
2. Press **Machine**.
3. Press **Operation**.
4. Press setting value to adjust settings as needed:
  - ◀ Application rate step – the percent of increase/decrease boost of the active application rate at which the product is applied
  - ◀ Speed source – selects whether to base the machine speed on input from the CAN , an Implement  or a Simulated  source
  - ◀ Simulated speed – establishes a speed for using the Simulated speed source
  - ◀ Minimum speed – establishes the minimum forward speed at which the system should automatically switch the main valve off
5. Press RETURN arrow  to return to the Machine screen.

Figure 12: Operation



Figure 13: Application rate step on Operation screen

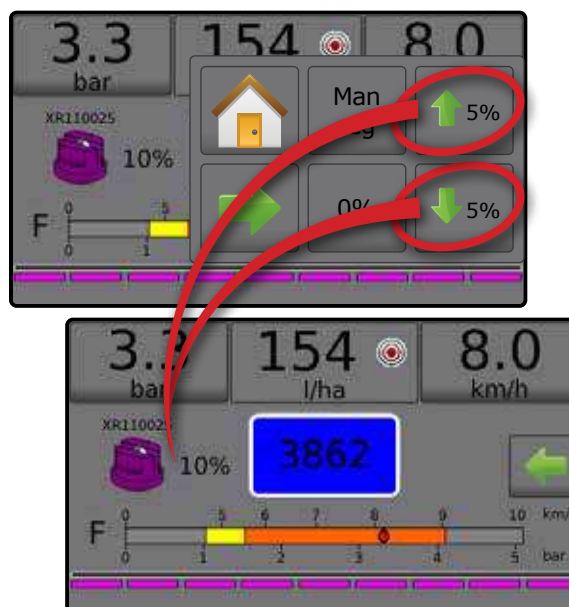

## Implement parameters





1. From the Home screen, press the SETTINGS button .
2. Press **Machine**.
3. Press **Implement parameters**.
4. Select from:
  - ▶ Section configuration – sets the number of nozzles on the boom which determines the spraying width during application
  - ▶ Nozzle preset setup – where up to five (5) sets of nozzle options can be established to set the nozzle series, capacity, low/high pressure limit, reference flow and reference pressure
  - ▶ Regulation parameters – where adjustments to the valve calibration, nozzle spacing and regulations mode can be established
5. Press RETURN arrow  to return to the Machine screen.

Figure 14: Implement parameters

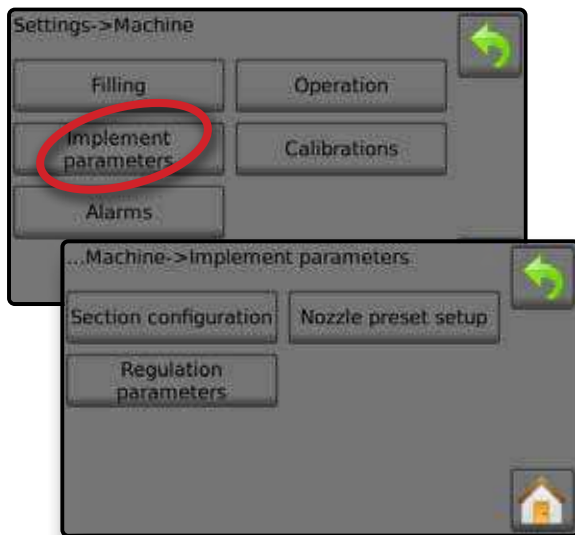

## Section configuration

Section configuration sets the number of nozzles on the boom which determines the spraying width during application.

1. From the Home screen, press the SETTINGS button .
2. Press **Machine**.
3. Press **Implement parameters**.
4. Press **Section configuration**.
5. Press setting value to adjust settings as needed:
  - ◀ Section number – establishes the current section number to which changes can be made. Sections are numbered from left to right while facing in the machine forward direction
  - ◀ Number of nozzles – establishes the number of nozzles in the current section number
  - ◀ Copy section – sets all Number of nozzles counts to the same count for all boom sections based upon the current Section number
  - ◀ Section width – displays the width for the current section
6. Press RETURN arrow  to return to the Implement parameters screen.

## Establish number of nozzles

1. From the Home screen, press the SETTINGS button .
2. Press **Machine**.
3. Press **Implement parameters**.
4. Press **Section configuration**.
5. Select Section number ①.
6. Set the number of nozzles ② for the selected section number.
7. Repeat steps 5 and 6 for additional Section numbers as available.
8. OPTIONAL: If all sections have the same number of nozzles, press **Copy** ③ to set all sections to the current number of nozzles.



Figure 15: Establish number of nozzles

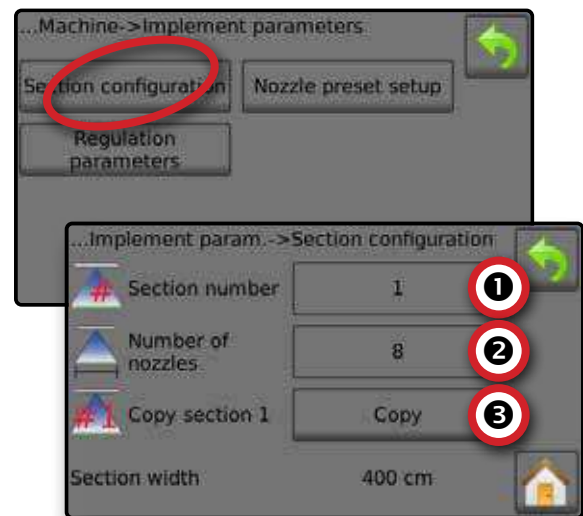

## Nozzle preset setup

Nozzle preset setup establishes up to five (5) sets of nozzle options setting the nozzle type, capacity, low/high pressure limit, reference flow and reference pressure.

NOTE: Settings on both screen 1 and screen 2 are specific to the currently selected Nozzle preset number.

1. From the Home screen, press the SETTINGS button .
2. Press **Machine**.
3. Press **Implement parameters**.
4. Press **Nozzle preset setup**.
5. Press setting value to adjust settings as needed:
  - ◀ Nozzle preset (number)
  - ◀ Nozzle series
  - ◀ Nozzle capacity
  - ◀ Factory settings
  - ◀ Low pressure limit
  - ◀ High pressure limit
  - ◀ Reference flow
  - ◀ Reference pressure
6. Press RETURN arrow  to return to the Implement parameters screen.

# Radion 8140 automatic sprayer control

## Establish nozzle presets



1. From the Home screen, press the SETTINGS button .
2. Press **Machine**.
3. Press **Implement parameters**.
4. Press **Nozzle preset setup**.
5. Select Nozzle preset number 1 ❶.
6. Select Nozzle series ❷.
7. Select Nozzle capacity ❸.
8. Repeat steps 5, 6 and 7 for Nozzle preset numbers 2 to 5.
9. OPTIONAL: Press NEXT PAGE arrow  ❹ to adjust the settings for Low pressure limit, High pressure limit, Reference flow and Reference pressure. Each of these settings are specific to the current nozzle preset number.

Figure 16: Establish nozzle presets



## Calibrations

For detailed instructions on sensor calibrations, see the Sensor calibrations section of this guide.

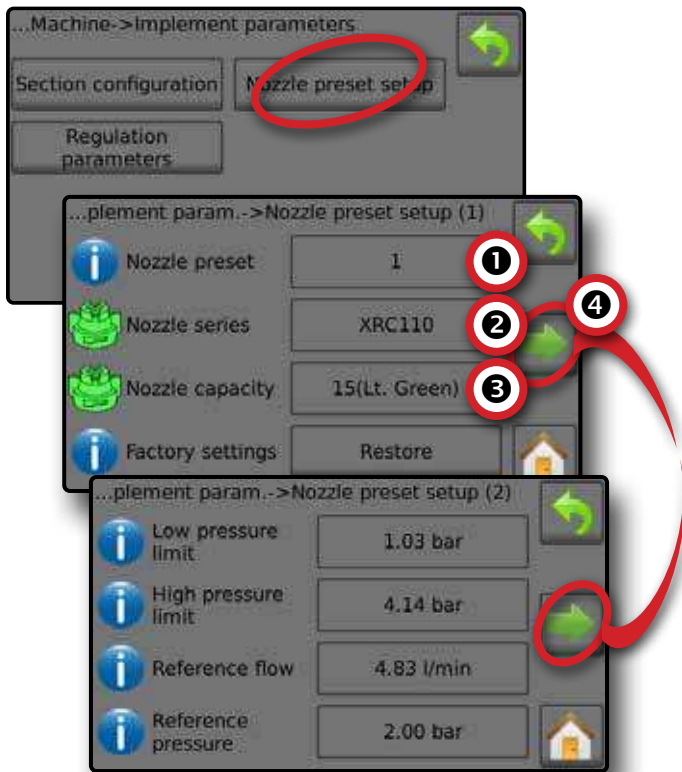

1. From the Home screen, press the SETTINGS button .
2. Press **Machine**.
3. Press **Calibrations**.
4. Select from:
  - ▶ Implement speed sensor – establishes the wheel impulses over a specified distance
  - ▶ Flow sensor – establishes the impulses per litre through the Flow sensor
  - ▶ Liquid pressure sensor – establish the maximum pressure limit and no pressure calibration for the liquid pressure sensor
    - ◀ Calibrate each option in the following order:
      - ❶ No pressure
      - ❷ Maximum pressure
  - ▶ Fill flow sensor – establishes the impulses per litre through the Fill flow sensor
  - ▶ Tank level sensor – establishes the empty, minimum and maximum levels for the tank and calibrates the tank shape
    - ◀ Calibrate each option in the following order:
      - ❶ Empty tank
      - ❷ Minimum tank level
      - ❸ Maximum tank level
      - ❹ Tank shape
5. Press the RETURN arrow  to return to the Machine screen.

Figure 17: Calibrations – Tank level sensor and Fill flow sensor



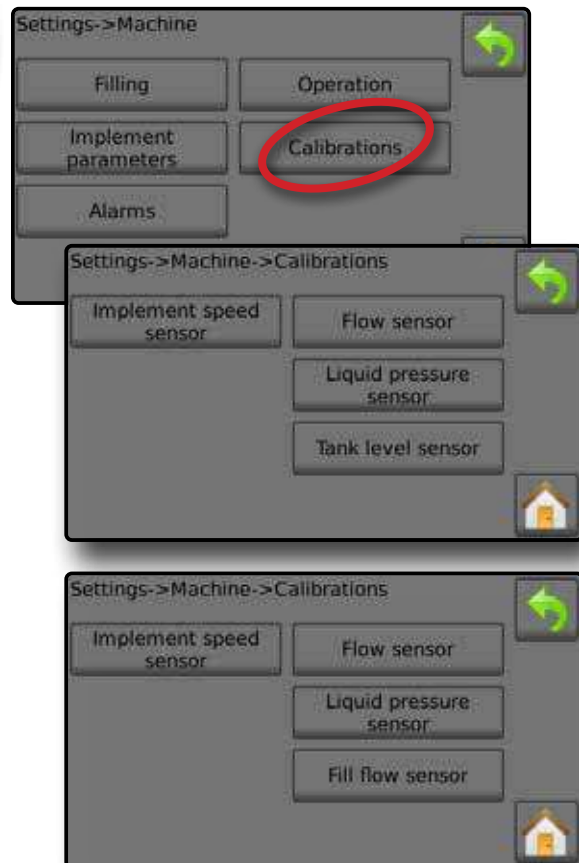

# Radion 8140 automatic sprayer control

## NO. 4 START NEW JOB OR CONTINUE JOB

 The Data option, provides an overview of various system counters including job counters, campaign counters and total counters. From Data options screens, export as either PDF or CSV reports.

6. From the Home screen, press the DATA button 
7. Select from:
  - ▶ Jobs – displays, deletes and reports on job information
  - ▶ Campaign – displays and deletes campaign information
  - ▶ Totals – displays all counter information
  - ▶ CSV – compiles a CSV report of counters for all jobs, and for the campaign and console totals, then saves reports to a USB drive

Figure 18: Data management options



### Jobs

One of up to ten (10) jobs may be selected to view job information. The current job, displayed/active on the Operation screen, may be exported as a PDF report.

Job information includes:







- ◀ Job number of information displayed
  - ◀ Current date
  - ◀ Applied area
  - ◀ Volume of material applied
  - ◀ Distance travelled
  - ◀ Time travelled
1. From the Home screen, press the DATA button 
  2. Press **Jobs**.
  3. Press **Job number** to view information for a different job.
    - ◀ Enter any number to display another job
  4. Press RETURN arrow  to return to the main Data screen.

Figure 19: Job data



### Job data report

The PDF button compiles active job information to be exported as a PDF report.

1. From the Home screen, press the DATA button 
2. Press **Jobs**.
3. Select the job from which to create a report.
4. Insert USB drive into the console and wait for PDF button  to activate.
5. Press PDF button 
6. Press RETURN arrow  to return to the main Data screen.

NOTE: The PDF icon  is not available for selection (greyed out) until a USB drive is inserted properly.

Figure 20: Job data



## SENSOR CALIBRATIONS

### Implement speed sensor

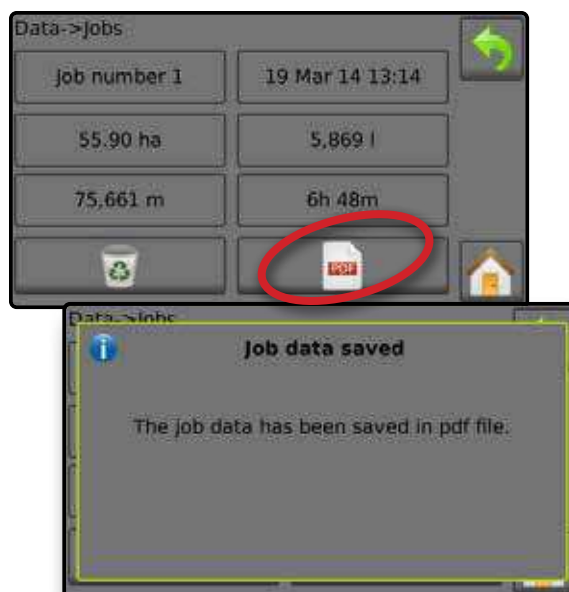
The Implement speed sensor establishes the wheel impulses over a specified distance. Establish the value manually or automatically calibrate the value.

- ▶ Calibration number –
  - ◀ Automatic calibration will determine the number of impulses counted while driving 100 metres and convert the calibration number to the correct units.
  - ◀ Manual calibration, enter the calibration number in impulses per 100 meters
- ▶ Automatic calibration – establishes the impulses using the automatic calibration function.

Figure 21: Implement speed sensor

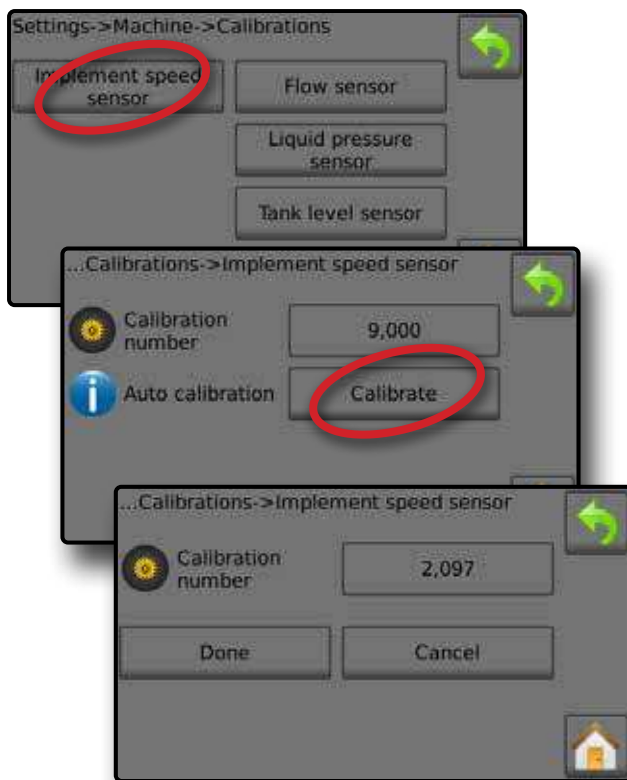

### Implement speed sensor automatic calibration

1. Press **Calibrate** to start an automatic sensor calibration.
2. Drive a distance of 100 metres.
3. Press **Done** when complete.

To cancel the calibration, press **Cancel**, RETURN arrow ↩ or the Home button 🏠.

The counted wheel impulses will be displayed during the automatic calibration.

### Flow sensor

The Flow sensor establishes the impulses per litre. Establish the value manually or automatically calibrate the value.

- ▶ Calibration number – enter the amount of impulses counted while running 1 litre of water through the flow sensor. Use Automatic calibration to calculate impulses automatically. Manual calibration establishes the calibration and limits based on user-entered values.
- ▶ Low flow limit – enter the flow sensors low limit value.
- ▶ High flow limit – enter the flow sensors high limit value.
- ▶ Automatic calibration – establishes the calibration and limits if the number of impulses per litre for the flow meter is unknown or to make sure the value is correct.
- ▶ Impulse count – shows the number of impulses during calibration. Minimum of 10 impulses needed to do a calibration.
- ▶ Collected volume – enter the volume passed through the flow sensor during the calibration. Once encoded, a new flow sensor calibration value is calculated.
- ▶ Master switch status / Cancel – shows if the Master switch is off  $\triangle$  or on  $\blacktriangle$ .  
Press the **Cancel** to cancel the calibration and return to the Flow sensor screen.

Figure 22: Flow sensor

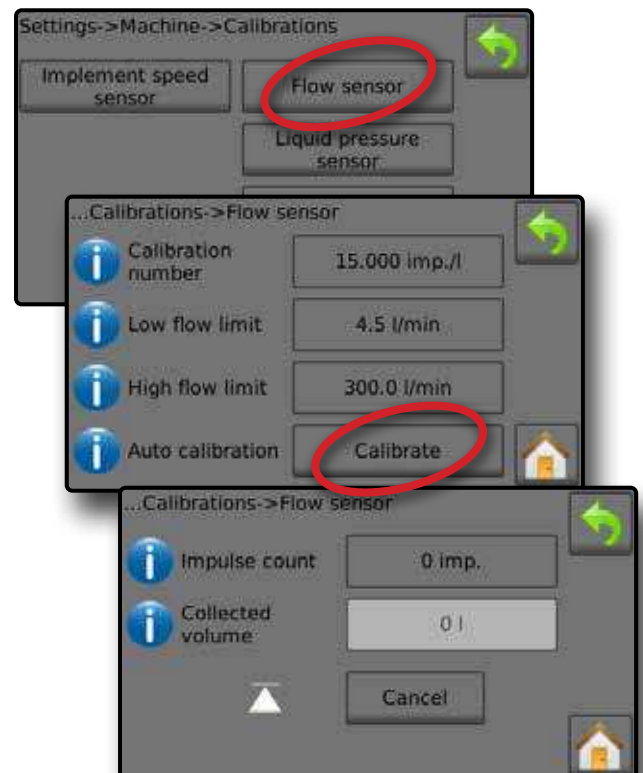

# Radion 8140 automatic sprayer control

## Flow sensor automatic calibration

1. Press **Calibrate** ❶ to enter automatic calibration mode.
2. Prepare to collect the 'medium' via the Flow sensor (minimum 100 litres).
3. Make sure the controller is in manual mode and flow is not regulated down.
4. Turn on the Master switch ❷ to start flow and calibration.
  - ◀ Impulses counted display during the automatic calibration
5. Once at the minimum 100 litres has distributed, turn off Master switch ❸ to stop calibration.
6. Press the Collected volume value ❹.
7. Enter the precise volume which passed through the flow sensor during the calibration.

Once encoded, a new flow sensor calibration value is calculated.

To cancel the calibration, press **Cancel**, RETURN arrow ↩ or the Home button 🏠.

Figure 23: Automatic calibration

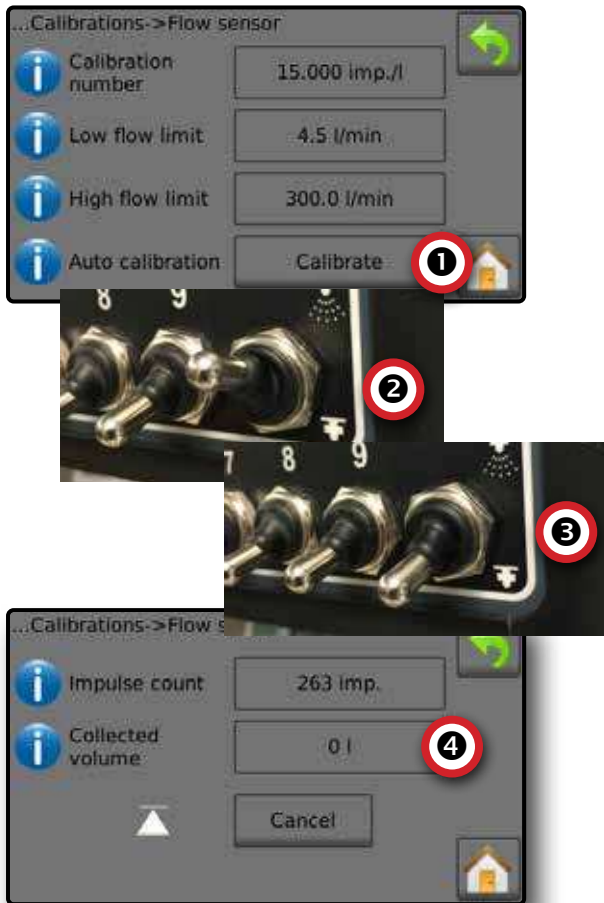

## Liquid pressure sensor

The liquid pressure sensor settings establish the maximum pressure limit and no pressure calibration for the liquid pressure sensor.

1. From the Home screen, press the SETTINGS button ⚙.
2. Press **Machine**.
3. Press **Calibrations**.
4. Press **Liquid pressure sensor**.
5. Calibrate each option in the following order:
  - ❶ No pressure
  - ❷ Maximum pressure
6. Press RETURN arrow ↩ to return to the Calibrations screen.

Figure 24: Liquid pressure sensor

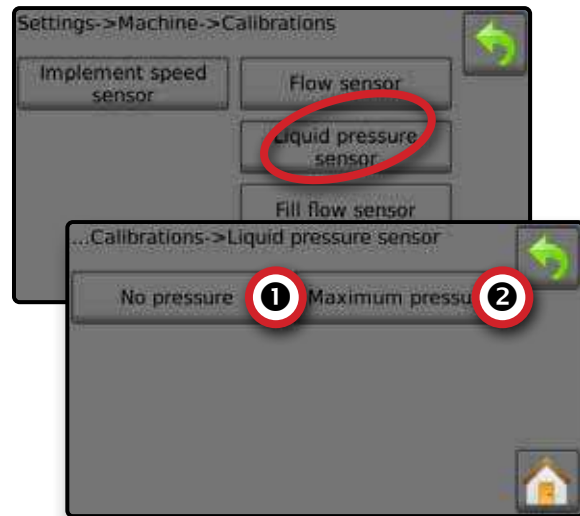

### ❶ No pressure

Liquid pressure sensor->No pressure establishes the calibration while **NO** pressure is applied to the liquid pressure sensor.

1. Remove all pressure from the system.
2. Press **Calibrate** to record a new calibration value and finalise the calibration.

NOTE: Manual calibration is not available.

Figure 25: Liquid pressure sensor->No pressure

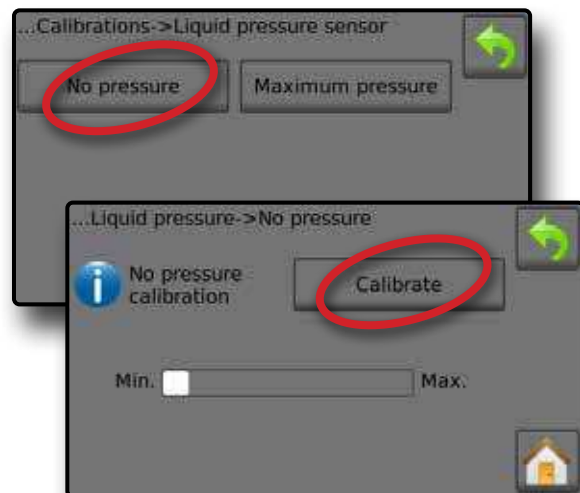



## ② Maximum pressure

Liquid pressure sensor->Maximum pressure establishes the maximum allowed pressure limit for the liquid pressure sensor. The automatic calibration is based on the recommended maximum pressure level and a tested reference pressure level.







- ▶ Maximum pressure – enter the maximum allowed pressure limit for the liquid pressure sensor. Use Automatic calibration to calculate the maximum pressure automatically.
- ▶ Reference pressure – enter the pressure value used as reference for the actual liquid pressure sensor calibration. The reference pressure can be changed, but not while in the calibration mode.
- ▶ Automatic calibration – if the maximum pressure is not known, or to make sure the value is correct, automatic calibration establishes the calibration.
- ▶ Complete calibration – apply constant reference pressure to the sensor. Press “Done” when complete.
- ▶ Master switch status / Pressure adjustment – Shows if the Master switch is off  or on . Press the UP/DOWN arrows   to increase/decrease the pressure until reaching and maintaining the reference pressure.
- ▶ Minimum/maximum pressure bar – illustrates the change in pressure from minimum to maximum.

Figure 26: Liquid pressure sensor->Maximum pressure

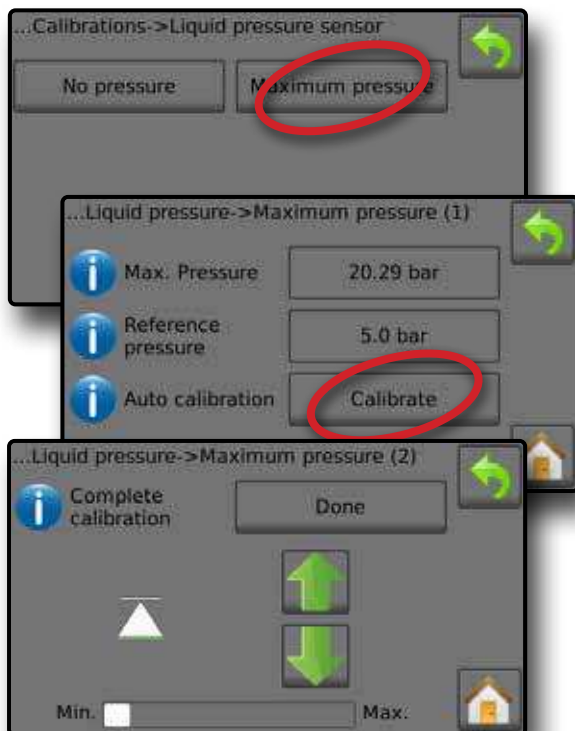

## Maximum pressure automatic calibration

**IMPORTANT:** Make sure all section valves are open before opening the Master valve; otherwise, the pressure could build and damage the system.

1. Press the Reference pressure value ①.
2. Enter the pressure value used as reference for the actual liquid pressure sensor calibration.
3. Press **Calibrate** ② to start an automatic calibration of the sensor.
4. Turn on Master switch ③.
5. Press the UP/DOWN arrows   ④ to increase/decrease the pressure until reaching and maintaining the reference pressure.
6. Apply constant reference pressure to the sensor.
7. Press **Done** ⑤ when complete.
8. Turn off Master switch ⑥ to stop calibration.



To cancel the calibration, press the RETURN arrow  or the Home button .

Figure 27: Automatic maximum pressure



# Radion 8140 automatic sprayer control

## Maximum pressure manual calibration

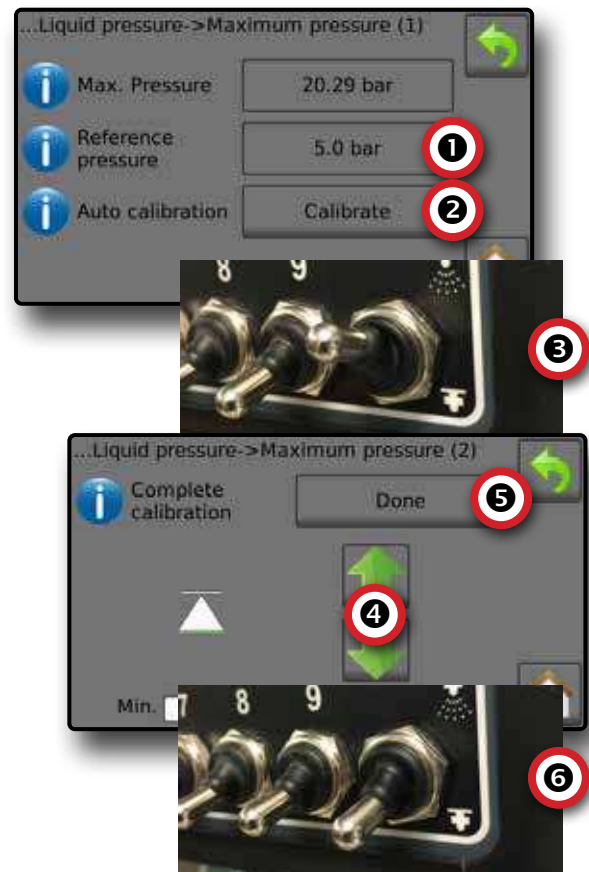
1. Press the Maximum pressure value ❶.
2. Enter the maximum allowed pressure limit for the liquid pressure sensor.

Figure 28: Manual maximum pressure

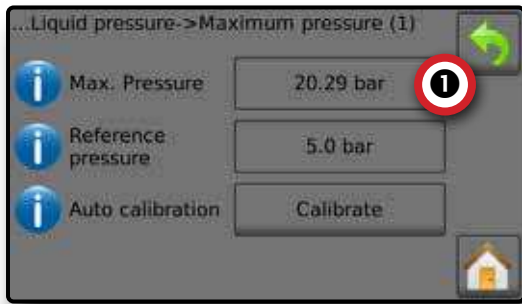

## Fill flow sensor

The Fill flow sensor establishes the impulses per litre. The Fill flow value can be established manually or automatically calibrated.

- ▶ Calibration number – enter the amount of impulses counted while running one (1) litre of water through the Fill flow sensor. Use Automatic calibration to calculate the impulses automatically. Manual calibration establishes the calibration and limits based on user entered values.
- ▶ Automatic calibration – establishes the calibration if the number of impulses per litre for the Fill flow meter is unknown, or to make sure the value is correct.
- ▶ Impulse count – number of impulses calculated during automatic calibration.
- ▶ Collected volume – enter the collected volume.
- ▶ Automatic calibration done – to complete the automatic calibration, press “Done” when collected volume has been entered.

Figure 29: Fill flow sensor

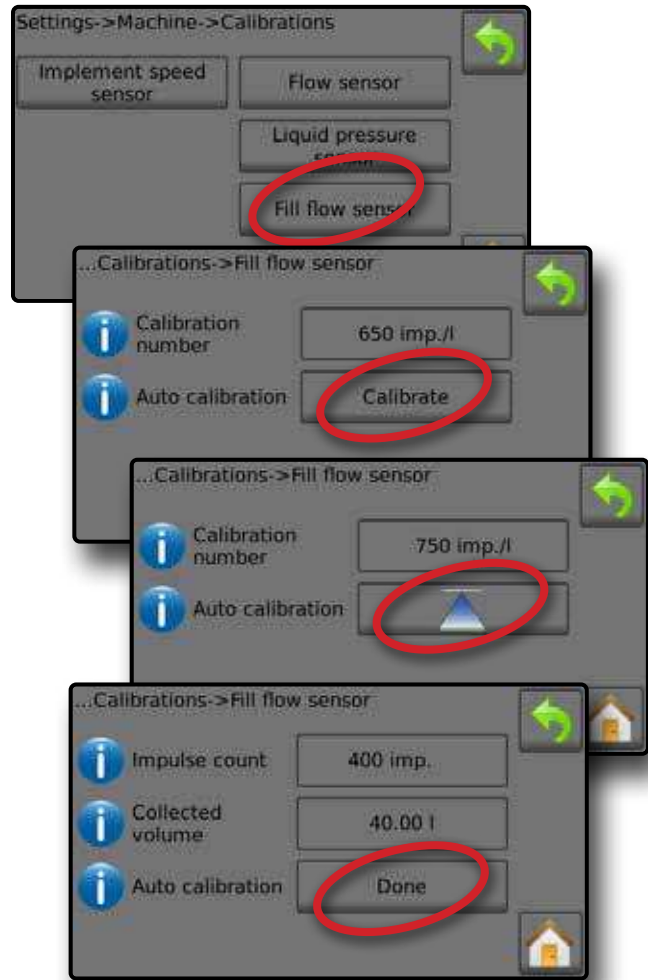

## Fill flow sensor automatic calibration

1. Press **Calibrate** ❶ to enter automatic calibration mode.
  2. Prepare to collect the 'medium' via the Fill flow sensor (minimum of 100 litres).
  3. Turn on Master switch ❷ to start flow.
  4. Press START CALIBRATION button ▲ ❸.
    - ◀ Impulses counted display during automatic calibration
  5. Once the desired amount has distributed, press the STOP CALIBRATION button △ ❹.
  6. Turn off the Master switch ❺.
  7. Press the Collected volume value ❻.
  8. Enter the precise volume passed through the Fill flow sensor during the calibration.
  9. Press **Done** ❼ to complete the automatic calibration.
- To cancel the calibration, press RETURN arrow ↩ or the Home button 🏠.

Figure 30: Fill flow sensor automatic calibration

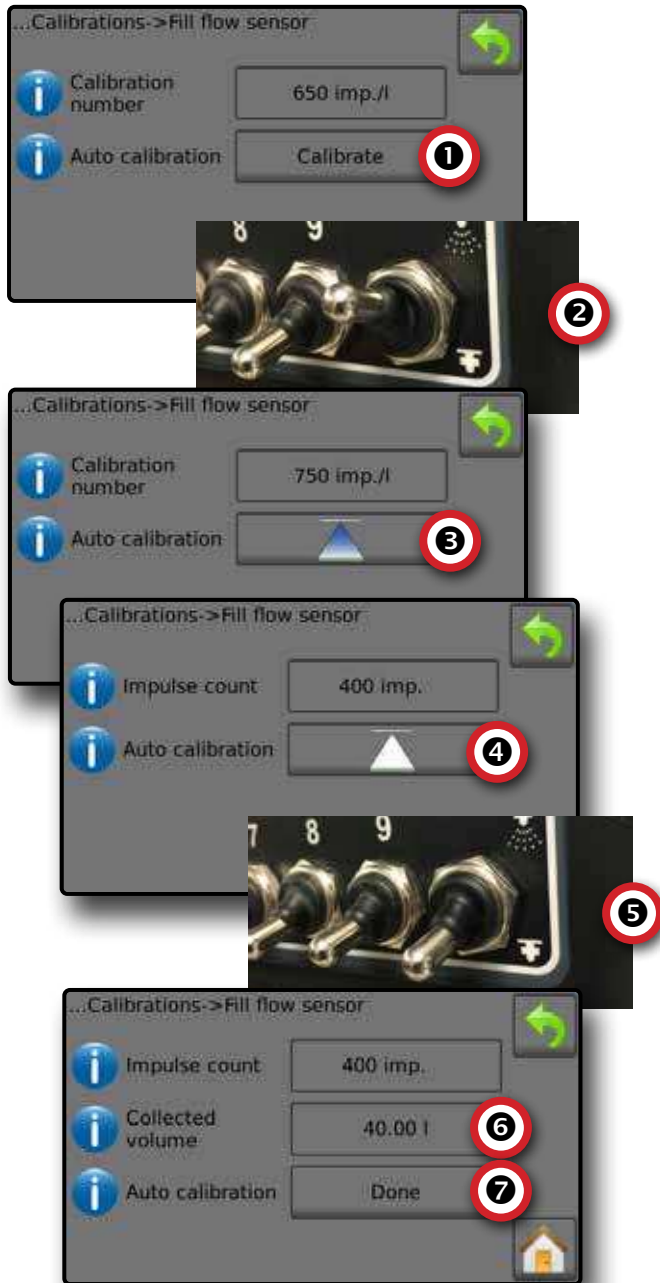

## Tank level sensor

Tank level sensor establishes the empty, minimum and maximum levels for the tank and calibrates the tank shape. Tank level sensor calibration settings can be exported to a USB drive and recalled for future use.

*NOTE: Manual calibration is not available for any Tank level sensor calibrations.*

1. From the Home screen, press the SETTINGS button
2. Press **Machine**.
3. Press **Calibrations**.
4. Press **Tank level sensor**.
5. Calibrate each option in the following order:
  - ❶ Empty tank
  - ❷ Minimum tank level
  - ❸ Maximum tank level
  - ❹ Tank shape
6. Press RETURN arrow to return to the Calibrations screen.

Figure 31: Tank level sensor

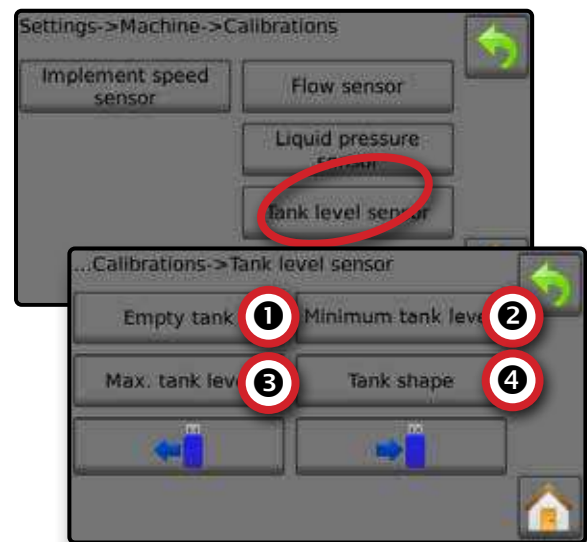

### ❶ Empty tank – Automatic calibration

Empty tank establishes the empty tank value.

*IMPORTANT: The tank should be completely empty.*

Figure 32: Empty tank

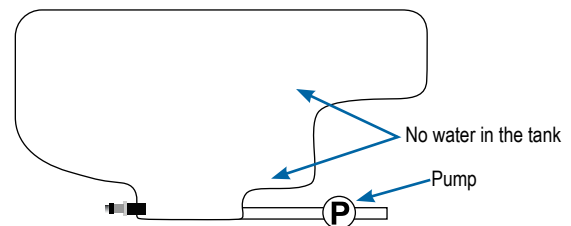

1. Press **Calibrate** to record a new calibration value and finalise the calibration.

◀The low-high graph should be empty

# Radion 8140 automatic sprayer control

Figure 33: Tank level sensor – Empty tank

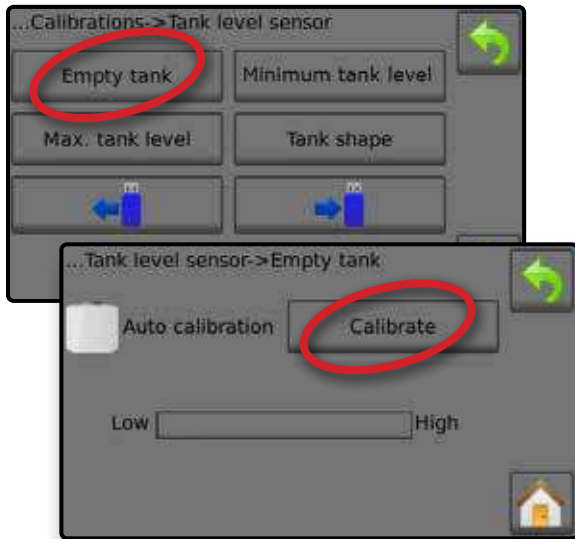

## 2 Minimum tank level – Automatic calibration

Minimum tank level establishes the minimum level of water on the tank sensor.

Figure 34: Minimum tank level

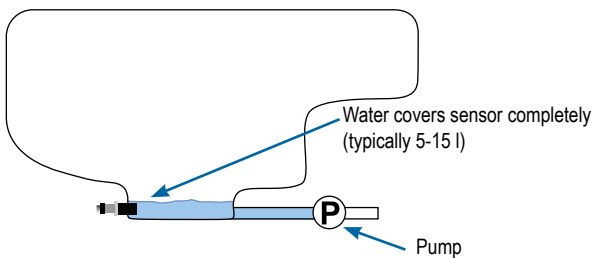

**IMPORTANT:** Make sure the tank is filled with the contents displayed on the screen. The amount displayed is established in Settings->OEM->Tank setup->Minimum tank content.

1. Press **Calibrate** to record a new calibration value and finalise the calibration.

◀ The low-high graph should display approximately 5% full

Figure 35: Tank level sensor – Minimum tank level

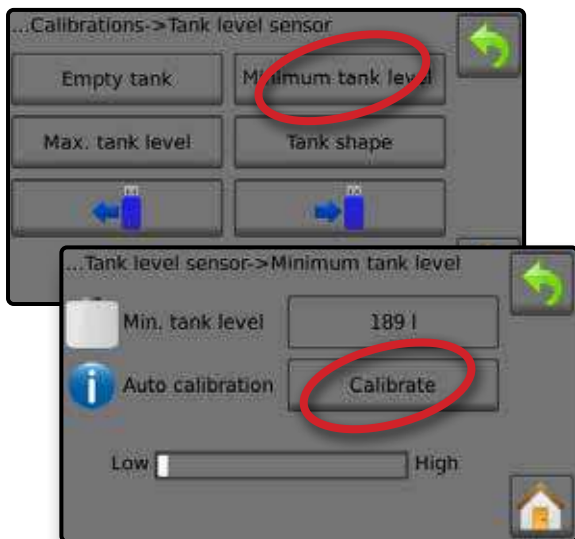

## 3 Maximum tank level – Automatic calibration

Maximum tank level establishes the maximum level of water on the tank sensor.

Figure 36: Maximum tank level

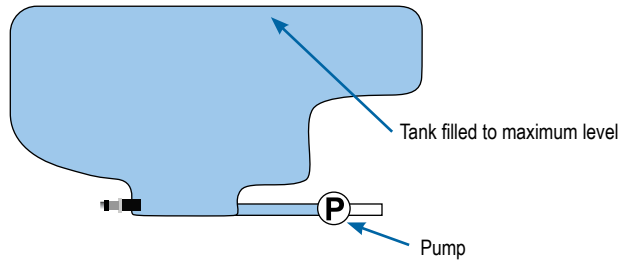

**IMPORTANT:** Ensure the tank is filled with the contents displayed on the screen. The amount displayed is established in Settings->OEM->Tank setup->Maximum tank content.

1. Press **Calibrate** to record a new calibration value and finalise the calibration.

◀ The low-high graph should display 100% full

Figure 37: Tank level sensor – Maximum tank level

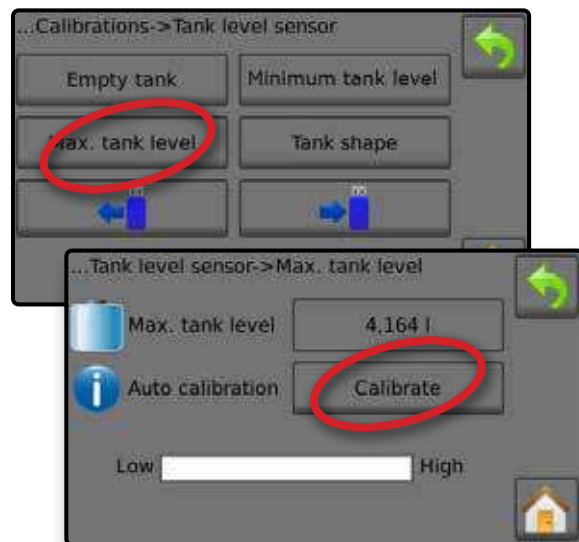

## 4 Tank shape – Automatic calibration

Tank shape establishes the tank shape.

Figure 38: Tank shape calibration

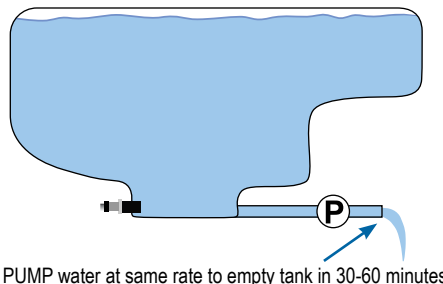

1. Flip Master switch to start calibration.

◀ Tank level sensor graph will go from high to low as the calibration proceeds

◀ When Calibration progress graph reaches 100%, calibration will record a new calibration value and finalise the calibration. To pause the calibration process, flip the Master switch.

To cancel the calibration, press RETURN arrow ↩ or press the Home button 🏠.

Figure 39: Tank level sensor – Tank shape

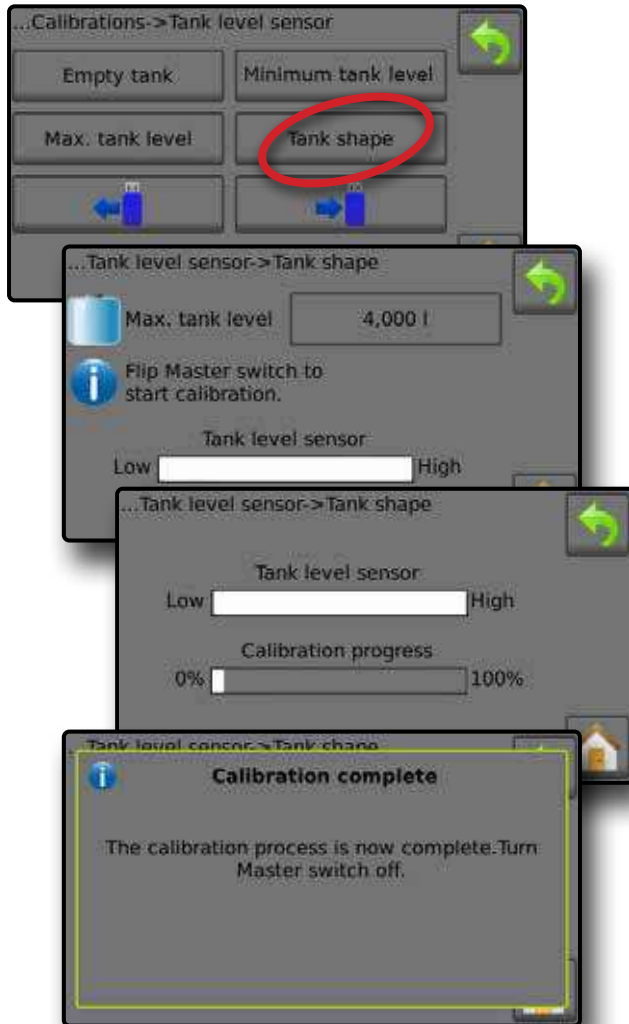

## Import / export

Tank level sensor calibration settings can be exported to USB drive and recalled for future use.

*NOTE: The import/export buttons ↶ ↷ are not available for selection and are greyed out until a USB drive is inserted properly.*

To import the calibration settings:

1. Insert USB drive.
2. Press IMPORT button ↶.

To export the calibration settings:

1. Insert USB drive.
2. Press EXPORT button ↷.

*NOTE: Only one (1) tank calibration settings file can be saved on a USB drive at one time. If there is an existing file it will be overwritten.*

Figure 40: Tank level sensor – Import/export

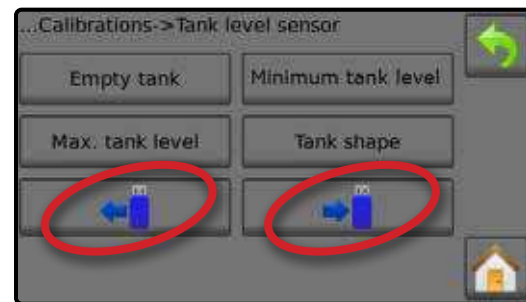

# Radion 8140 automatic sprayer control

## OPERATION SCREEN

### INFORMATION BAR

The information bar displays user selected information and application rate information.

Figure 41: Information bar

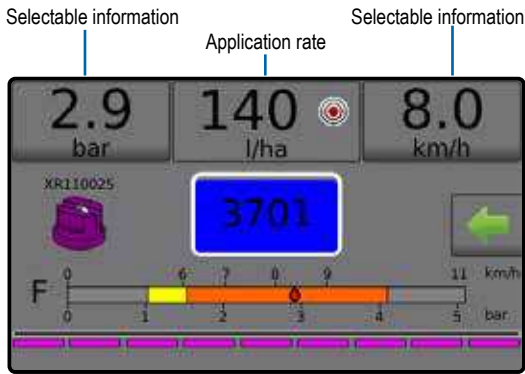

### Selectable information

Selectable information displays user-selected information.

1. Press either the left or right Selectable information section.
2. Select one (1) of six (6) available options to display for each side (options depend upon equipment in use).
  - ▶ Volume applied – displays volume applied for the current job number
  - ▶ Flow rate – displays current flow rate
  - ▶ Flow pressure – displays current flow pressure
  - ▶ Speed – displays vehicle speed
  - ▶ Area applied – displays applied area for the selected job number
  - ▶ Job number – displays the current job number

Figure 42: Selectable information



Figure 43: Selectable information options

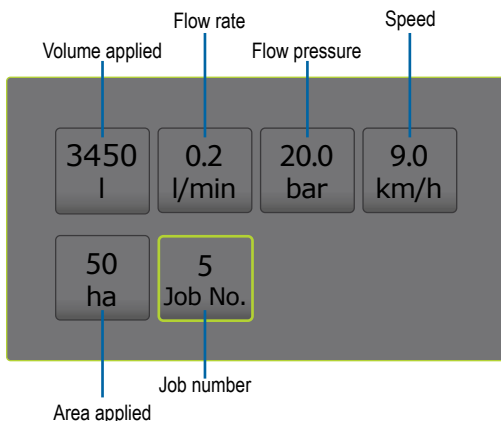

### Selecting a job number

One of up to ten (10) jobs may be selected to view job information.





1. From the Operation screen, press the OPTIONS tab
2. Press the HOME button
3. From the Home screen, press the DATA button
4. Press **Jobs**.
5. Press **Job number** to select current job number.
6. Press the HOME button
7. From the Home screen, press the OPERATION button

Figure 44: Selecting a job number



## Application rate

Application rate displays or give access to:

- ▶ Application rate – while application is active, displays the actual application rate
- ▶ Target application rate – while application is inactive, displays the target rate of product to apply.
  - ◀ Automatic regulation mode – Target application rate symbol will be active 
    - Use the Boost/step percent increase/decrease buttons   to adjust the target application rate
  - ◀ Manual regulation mode – manual regulation symbol will remain active 
- ▶ Preset target application rates options menu – defines the target rate of product to apply for the selected number. These settings will be the same for all active jobs. Range is 0 to 6,554 litres/hectare.

## Select target application rate

1. Press the Application rate section.
2. Select one (1) of up to three (3) preset application rates.

Figure 45: Select target application rate

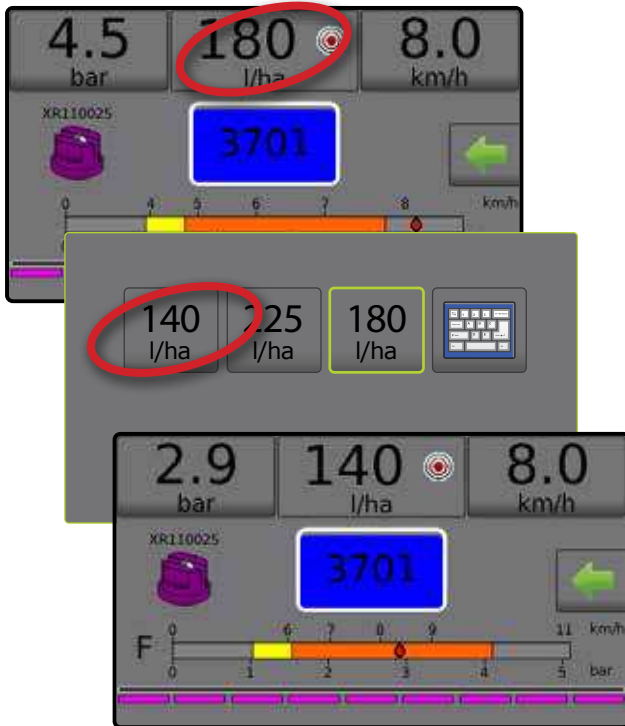

## Change preset target application rate

The selected target rate can be changed either on the Operation screen or in Settings->Job parameters.

### Operation

1. Press the Application rate section.
2. Select the target application rate to be changed.
3. Press KEYBOARD button .
4. Select an application rate.

NOTE: Value must be between 0 and 6,554 litres/hectare.

Figure 46: Application rate number

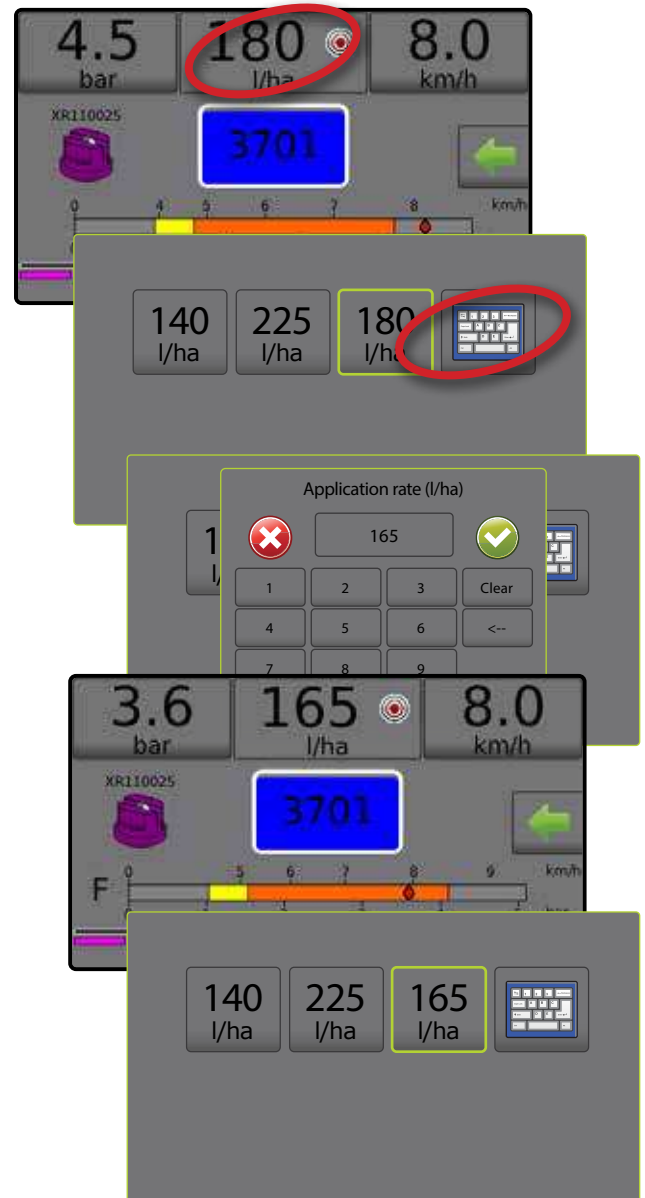

# Radion 8140 automatic sprayer control

## Settings



1. From the Home screen, press the SETTINGS button .
2. Press **Job parameters**.
3. Select Application rate number 1 .
4. Select an application rate  to be associated with number 1.
5. Repeat steps 3 and 4 for Application rate numbers 2 and 3.

Figure 47: Establish preset target application rate 2





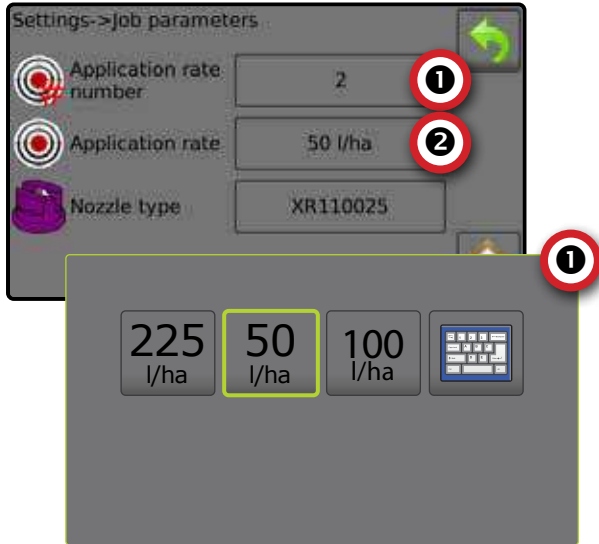

## Target rate percentage increase/decrease

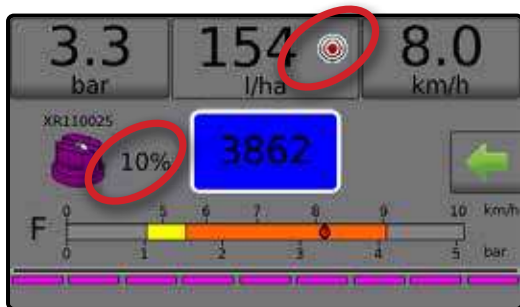
Target rate boost/step percent increase/decrease buttons increase/decrease the application target rate per the established percentage set in the Settings->Machine->Operation setup screen under Application rate step.

Figure 48: Target rate boost/step percent



## Increase/decrease percentage

1. From the Operation screen, press the OPTIONS tab  to display the Operation menu.
2. Press the Boost/step percent increase/decrease buttons   to adjust application rates.
3. Press the Close menu button .

## Return to preset target rate



1. From the Operation screen, press the OPTIONS tab  to display the Operation menu.
2. Press **0%** to return to the preset target rate.
3. Press the Close menu button .

Figure 49: Application rate step



## Change application rate step

Application rate step is the percent of increase/decrease boost of the active application rate at which the product is applied. Range is 1 to 20%.

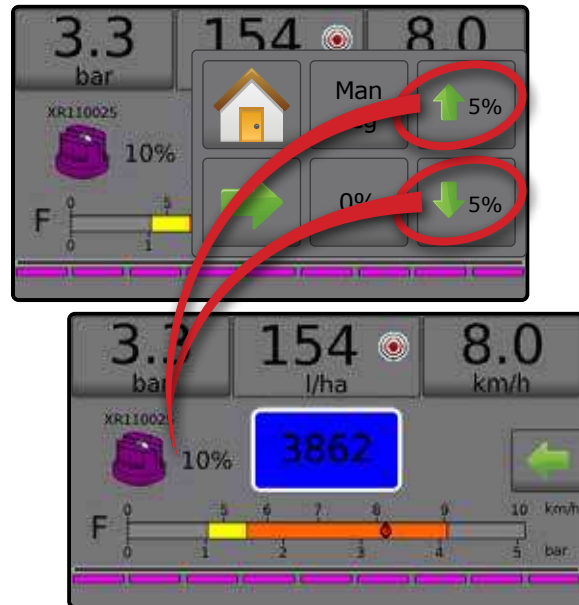

1. From the Home screen, press the SETTINGS button .
2. Press **Machine**.
3. Press **Operation**.
4. Press Application rate step value .
5. Select an application rate step.
6. Press RETURN arrow  to return to the Machine screen.

Figure 50: Operation





## NOZZLE SELECTION

Nozzles must be preset to be available for current nozzle selection. Presets allow saving of up to five (5) nozzles for quick recall.

### Selecting the current nozzle

1. From the Operation screen, press the CURRENT NOZZLE  to display the Preset nozzle menu.
2. Select a nozzle type from among five (5) nozzle presets.

*NOTE: Current nozzle can also be selectable on the Settings->Job parameters screen.*

Figure 51: Nozzle type on Operation screen

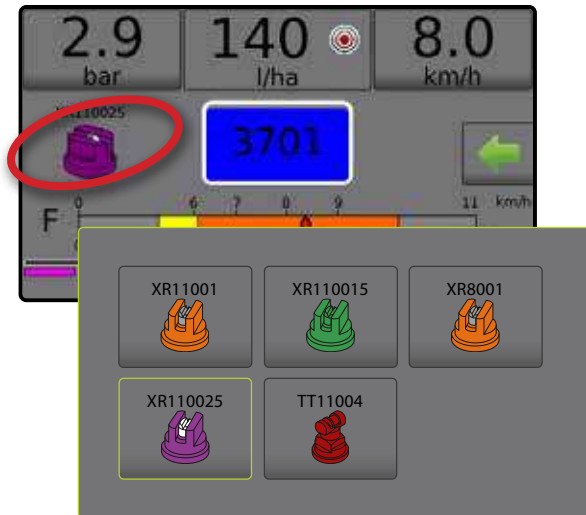

### Presetting nozzles

Nozzle preset setup establishes up to five (5) sets of nozzle options setting the nozzle type, capacity, low/high pressure limit, reference flow and reference pressure. For more information see Settings->Machine->Implement parameters->Nozzle preset setup.



1. From the Home screen , press the SETTINGS button .
2. Press **Machine**.
3. Press **Implement parameters**.
4. Press **Nozzle preset setup**.
5. Select Nozzle preset number 1 **1**.
6. Select Nozzle series **2**.
7. Select Nozzle capacity **3**.
8. Repeat steps 5, 6 and 7 for Nozzle preset numbers 2 to 5.
9. OPTIONAL: Press NEXT PAGE arrow  **4** to adjust the settings for Low pressure limit, High pressure limit, Reference flow and Reference pressure. Each of these settings are specific to the current nozzle preset number.

Figure 52: Establish nozzle presets



# Radion 8140 automatic sprayer control

## TANK

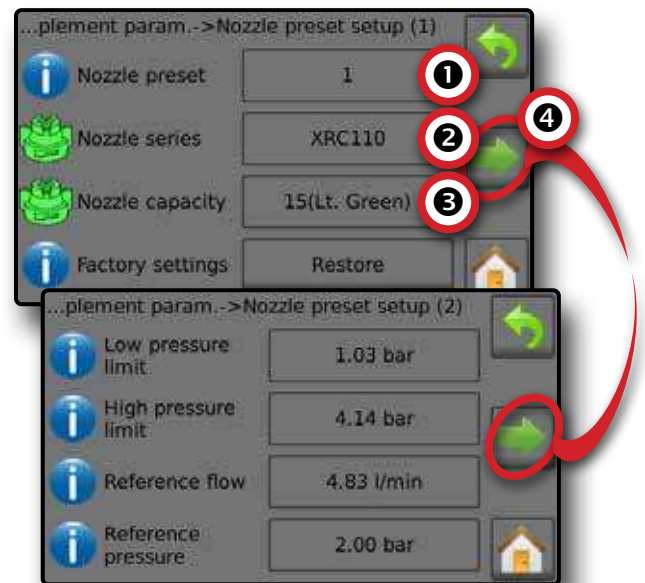
Tank displays or give access to:

- ▶ Actual content – displays the current volume of content in the tank. Manual adjustment is directly relate to OEM fitted equipment. The volume cannot be manually adjusted if a Tank sensor is active.
- ▶ Tank filling – establishes the amount of actual and desired material in the tank and the density of that material. Options displayed directly relate to OEM fitted equipment. Different options will be available depending upon if a Tank sensor or Fill flow sensor is active. See Settings->Machine->Filling for additional information.

1. Press TANK **100**.

2. Press setting value to adjust settings as needed:

- ◀ Actual content (unavailable when Tank sensor is active)
- ◀ Full tank (unavailable when Tank sensor or Fill flow sensor is active)
- ◀ Density type
- ◀ Density factor (available when Density type is Fertiliser)
- ◀ Desired content (available when Tank sensor or Fill flow sensor is active)
- ◀ Automatic filling (available when Tank sensor or Fill flow sensor is active)

3. Press RETURN arrow  to return to the Operation screen.

Figure 53: Tank filling



## ALARM WARNING

If there is an active alarm, an Alarm warning icon will appear next to the Tank. For a list of Alarm message codes see Appendix C – Alarm configurations.

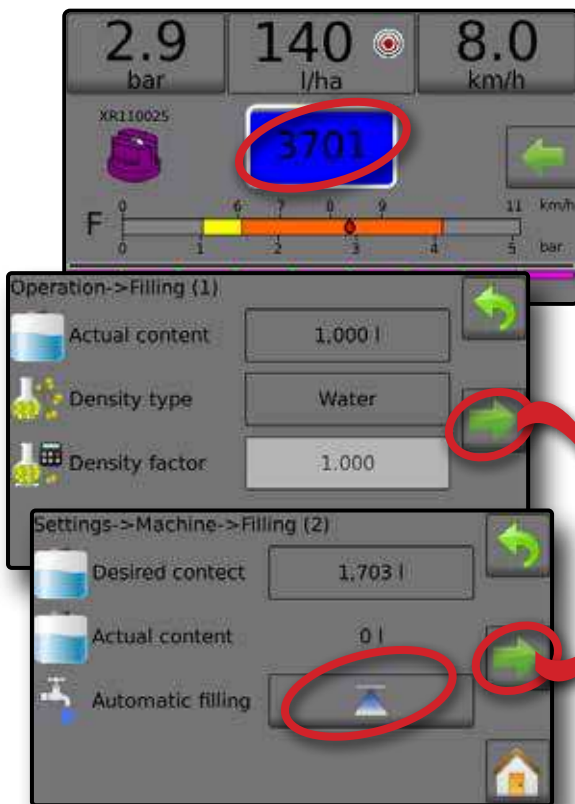
1. Press ALARM WARNING icon  to display a list all active alarms.

Figure 54: Active alarm warning list

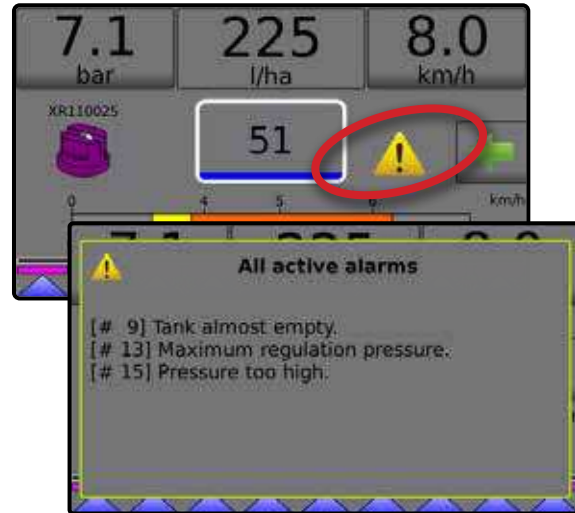

### Set up alarms

1. From the Home screen, press the SETTINGS button .

2. Press **Machine**.

3. Press **Alarms**.

4. Press setting value to adjust settings as needed:

- ◀ Minimum tank content
- ◀ Flow/pressure cross check (alarm active only when both a Flow sensor and Liquid pressure sensor are active)
- ◀ Section output low

5. Press RETURN arrow  to return to the Machine screen.

Figure 55: Alarms

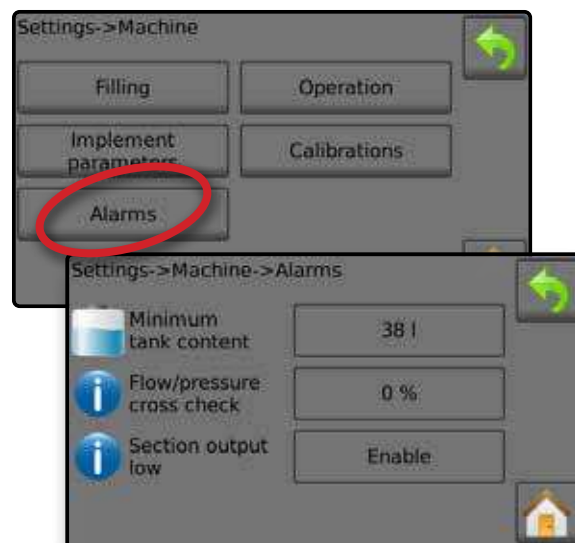

## PRESSURE GAUGE

The Pressure gauge displays current pressure compared with the recommended pressure range. Pressure sensor options are used to enter the sensor manufacturer maximum pressure rating and to set high and low user-determined pressure alarms.

Figure 56: Pressure gauge example

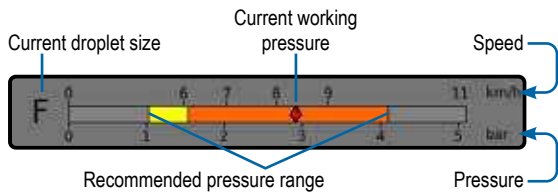

### Recommended pressure range

Displays the recommended pressure range for the selected nozzle. The pressure range will change depending upon the selected nozzle, target application rate (including boost/step percent increase/decrease) and working speed.

**IMPORTANT!** Always refer to the recommended pressure range as failure to do so may result in uneven spray patterns.

### Current working pressure

Displays the current working pressure.

**NOTE:** This pressure range should not exceed the recommended pressure range.

**IMPORTANT!** Always refer to the recommended nozzle pressure values when setting nozzle pressure.

### Current droplet size

A single nozzle can produce different droplet size classifications at different pressures. The colours displayed in the recommended pressure range are directly associated with the current droplet sizes. The droplet size displays as one (1) of eight (8) classification categories.

Table 1: Droplet size chart

Category	Symbol	Colour code
Extremely fine	XF	Violet
Very fine	VF	Red
Fine	F	Orange
Medium	M	Yellow
Coarse	C	Green
Very coarse	VC	Blue
Extremely coarse	XC	White
Ultra coarse	UC	Black

**NOTE:** Droplet size classification is in accordance with ISO 25358 at the date of publication. Classifications are subject to change.

# Radion 8140 automatic sprayer control

## USER SETTING NOTES

### Settings-> Job parameters

Description	User setting
Target application rates	No. 1
	No. 2
	No. 3

NOTE: Go to Settings->Job parameters->Application rate; or go to Settings->Machine->Implement parameters->Nozzle preset setup.

### Settings-> Machine-> Filling

Description	User setting
Density type	
Density factor (fertiliser)	

NOTE: Go to Operation->Filling (1) and (2) (via Tank icon) or go to Settings->Machine->Filling (1) and (2).

### Settings-> Machine-> Operation

Description	User setting
Application rate step	
Speed source	
Simulated speed	
Minimum speed	

NOTE: Go to Settings->Machine->Operation.

### Settings-> Machine-> Implement parameters

#### Section configuration

Description	User setting
Number of nozzles Section 1	
Number of nozzles Section 2	
Number of nozzles Section 3	
Number of nozzles Section 4	
Number of nozzles Section 5	
Number of nozzles Section 6	
Number of nozzles Section 7	
Number of nozzles Section 8	
Number of nozzles Section 9	
Number of nozzles Section 10	
Number of nozzles Section 11	
Number of nozzles Section 12	
Number of nozzles Section 13	

NOTE: Go to Settings->Machine->Implement parameters-> Section configuration.

The number of available sections is dependent upon the console model.

### Nozzle preset setups

Nozzle preset No. 1	User setting
Nozzle series	
Nozzle capacity	
Low pressure limit	
High pressure limit	
Reference flow	
Reference pressure	

Nozzle preset No. 2	User setting
Nozzle series	
Nozzle capacity	
Low pressure limit	
High pressure limit	
Reference flow	
Reference pressure	

Nozzle preset No. 3	User setting
Nozzle series	
Nozzle capacity	
Low pressure limit	
High pressure limit	
Reference flow	
Reference pressure	

Nozzle preset No. 4	User setting
Nozzle series	
Nozzle capacity	
Low pressure limit	
High pressure limit	
Reference flow	
Reference pressure	

Nozzle preset No. 5	User setting
Nozzle series	
Nozzle capacity	
Low pressure limit	
High pressure limit	
Reference flow	
Reference pressure	

NOTE: Go to Settings->Machine->Implement parameters-> Nozzle preset setup to access nozzle preset setups.

### Regulation parameters

Description	User setting
Course valve calibration	
Fine valve calibration	
Nozzle spacing	
Regulation mode	

NOTE: Go to Settings->Machine->Implement parameters-> Regulation parameters.

## Settings-> Machine-> Calibrations

### Implement speed sensor

Description	User setting
Calibration number	

NOTE: Go to Settings->Machine->Calibrations->Implement speed sensor. Some options may not be available depending upon OEM sensor settings.

### Flow sensor

Description	User setting
Calibration number	
Low flow limit	
High flow limit	

NOTE: Go to Settings->Machine->Calibrations->Flow sensor. Some options may not be available depending upon OEM sensor settings.

### Liquid pressure sensor - maximum pressure option

Description	User setting
Maximum pressure	
Reference pressure	

NOTE: Go to Settings->Machine->Calibrations->Liquid pressure sensor->Maximum pressure sensor. Some options may not be available depending upon OEM sensor settings.

### Fill flow sensor

Description	User setting
Calibration number	

NOTE: Go to Settings->Machine->Calibrations->Fill flow sensor. Some options may not be available depending upon OEM sensor settings.

### Tank level sensor

NOTE: Manual calibration is not available for any Tank level sensor calibrations.

## Settings-> Machine-> Alarms

Description	User setting
Minimum tank content	
Flow/pressure cross check	
Section output low	

NOTE: Go to Settings->Machine->Alarms.

# Radion 8140 automatic sprayer control

## ALARM CONFIGURATIONS

Code	Message / condition	Possible solution	Console path
1	No flow impulses	Check flow sensor from test menu. Check components and programming steps related to flow.	Settings->Diagnostics->Test inputs (1)->Flow sensor
2	Low liquid pressure	Check flow sensor from test menu. Check components and programming steps related to flow.	Settings->Machine->Implement parameters->Nozzle preset setup (2) or Settings->Machine->Calibrations or Settings->Diagnostics->Test inputs (2)->Liquid pressure sensor
4	Calibration error	Check components and programming steps related to implement or process registering a calibration error.	Settings->Machine->Calibrations - check sensors
5	Density not equal to water (1 kg/l or 8.34 lb/gal)	Select Water for tank contents or change fertiliser density No.. Check components and programming steps related to content.	Operation->Filling (1) or Settings->Machine->Filling (1)
6	Below minimum speed	Increase speed. Check components and programming steps related to speed.	Settings->Machine->Operation or Settings->Machine->Calibrations->Implement speed sensor
7	Pressure based	Check components and programming steps related to implement or process registering a pressure error.	Settings->Diagnostics->Test inputs or Settings->Machine->Implement parameters->Nozzle preset setup (2)
8	Low flow	Increase speed. Check or clean nozzles. Check components and programming steps related to flow.	Settings->Diagnostics->Test inputs or Settings->Machine->Implement parameters->Nozzle preset setup (2)
9	Tank almost empty	Refill tank. Check all components and programming steps related to contents.	Operations->Tank->Filling (1) or Settings->Machine->filling (1) and (2) or Settings->Machine->Alarms->Minimum tank contents
10	Target rate impossible to reach	Select a new target rate. Use larger nozzles. Check components and programming steps related to rates.	Operation->Target rates or Settings->Job parameters
11	Actual rate too high	Select a lower target rate. Check components and programming steps related to rates.	Operation->Target rates or Settings->Job parameters
12	Minimum regulation pressure	Check components and programming steps related to pressure.	Settings->Machine->Implement parameters->Regulation parameters
13	Maximum regulation pressure	Check components and programming steps related to pressure.	Settings->Machine->Implement parameters->Regulation parameters
14	Pressure too low	Check components and programming steps related to pressure.	Settings->Machine->Implement parameters->Nozzle preset setup (2)
15	Pressure too high	Check components and programming steps related to pressure.	Settings->Machine->Implement parameters->Nozzle preset setup (2)
16	Pressure/flow check	Check components and programming steps related to flow.	Settings->Diagnostics->Test inputs or Settings->Machine->Calibrations
19	Liquid pressure too low	Check flow sensor from test menu. Check components and programming steps related to pressure.	Settings->Machine->Implement parameters->Nozzle preset setup (2) or Settings->Machine->Calibrations or Settings->Diagnostics->Test inputs (2)->Liquid pressure sensor
20	Liquid pressure too high	Check flow sensor from test menu. Check components and programming steps related to pressure.	Settings->Machine->Implement parameters->Nozzle preset setup (2) or Settings->Machine->Calibrations
21	No speed signal	Check components and programming steps related to speed.	Settings->Machine->Calibrations->Implement speed sensor
31	Work not possible		
34	Save error	Insert or reset a USB device if saving to a USB port.	
36	CAN speed missing	Check GNSS source for power/satellite reception. If no GNSS source, change speed source. Check components and programming steps related to speed.	Settings->Machine->Operation->Speed source
45	BoomPilot unit not responding	Check BoomPilot for power. Test BoomPilot under test menu.	Settings->Diagnostics->Test BoomPilot
46	BoomPilot unit in manual mode	Current operation mode is different than standard operation. If this is undesired, change mode to automatic under test menu.	Settings->Diagnostics->Test BoomPilot
47	Not all sections on	Current operation mode is different than standard operation. If this is undesired, check section switches are flipped up (ON). Check sections under test menus. Configure sections. Check components and programming steps related to power.	Settings->Diagnostics->Test outputs (2) or Settings->Diagnostics->Test inputs (3)->Section switches or Settings->Machine->Implement parameters->Section configuration
49	Section output failure	Check components and programming steps related to sections.	Settings->Diagnostics->Test outputs (2)
50	Master output failure	Check Master switch if flipped up (ON). Check all components and programming steps related to Master switch.	Settings->Diagnostics->Test inputs (3)->Master switch
51	Fill valve output failure	Check fill valve under test menus. Check components and programming steps related to fill valve.	Settings->Diagnostics->Test outputs (2)->Fill valve
52	Low supply voltage	Check voltage supply under Diagnostics.	Settings->Diagnostics->Supply voltage

## UNIT SPECIFICATIONS

Dimensions	Radion 8140, 5-section	228.6 x 158.0 x 61.6 mm
	Radion 8140, 7-section	228.6 x 158.0 x 61.6 mm
	Radion 8140, 9-section	254.0 x 158.0 x 61.6 mm
Weight	Radion 8140, 5-section	1.3 kg
	Radion 8140, 7-section	1.6 kg
	Radion 8140, 9-section	1.9 kg
Connector	Power/CAN	8-pin Conxall
	Speed/status	8-pin Conxall
	Main	28-pin
	Serial	9-pin
Environmental	Storage	-10 to +70°C
	Operating	0 to +50°C
	Humidity	90% non-condensing
Display	Radion 8140	320 x 240 resolution 4.3"
Input/output		USB 2.0
Power requirement		< 9 watts @ 12 VDC

# RADION 8140

## USER GUIDE

### NO.1 POWER ON

### NO.2 OPERATION SCREEN

### NO. 3 GO TO HOME

#### 1) SET UP THE LOCAL CULTURAL SETTINGS

#### 2) SET UP THE JOB PARAMETERS

#### 3) SET UP THE MACHINE

- 1) Operation
- 2) Implement parameters
- 3) Verify sensor calibrations

### NO. 4 START NEW JOB OR CONTINUE JOB



[www.teejet.com](http://www.teejet.com)

A Subsidiary of  **Spraying Systems Co.**

98-01467-EN-A4 R6 English International  
© TeeJet Technologies 2021

#### Copyrights

© 2021 TeeJet Technologies. All rights reserved. No part of this document or the computer programmes described in it may be reproduced, copied, photocopied, translated, or reduced in any form or by any means, electronic or machine readable, recording or otherwise, without prior written consent from TeeJet Technologies.

#### Trademarks

Unless otherwise noted, all other brand or product names are trademarks or registered trademarks of their respective companies or organizations.

#### Limitation of Liability

TEEJET TECHNOLOGIES PROVIDES THIS MATERIAL "AS IS" WITHOUT WARRANTY OF ANY KIND, EITHER EXPRESSED OR IMPLIED. NO COPYRIGHT LIABILITY OR PATENT IS ASSUMED. IN NO EVENT SHALL TEEJET TECHNOLOGIES BE LIABLE FOR ANY LOSS OF BUSINESS, LOSS OF PROFIT, LOSS OF USE OR DATA, INTERRUPTION OF BUSINESS, OR FOR INDIRECT, SPECIAL, INCIDENTAL, OR CONSEQUENTIAL DAMAGES OF ANY KIND, EVEN IF TEEJET TECHNOLOGIES HAS BEEN ADVISED OF SUCH DAMAGES ARISING FROM TEEJET TECHNOLOGIES SOFTWARE.