

**TANKJET 27500 AND 27500-R TANK CLEANING NOZZLE  
FEATURES AND BENEFITS**

- With rotation driven by the reactionary force of the cleaning liquid, these nozzles provide excellent cleaning and rinsing and are especially well-suited for clean-in-place (CIP) systems
- Spray angles range from 180° to 360° and can be used to clean specific areas or the entire tank interior
- Made of corrosion- and chemical-resistant PTFE fluoropolymer resin, both models provide peak performance when used with debris-free liquid and deliver greater impact than static spray balls
- 27500-R nozzles with removeable spray heads, 1/2 in. and 3/4 in. inlet connections, are also available in carbon-filled PTFE for improved thermal characteristics and higher mechanical strength. See page D4 and E4
- ATEX-certified versions available



TankJet 27500 tank cleaning nozzle

TankJet 27500-R tank cleaning nozzle, see page D4 and E4



**SPRAY COVERAGE**

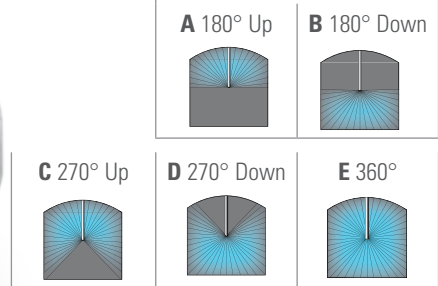

**MOUNTING OPTIONS**

Vertical	↑	↓
Horizontal	←	→
45° Up	↖	↗
45° Down	↘	↙

**SPECIFICATIONS**

TankJet 27500 Tank Cleaning Nozzles	
Max. tank diameter:	25 ft. (7.6 m)
Operating principle:	Fluid-driven reactionary force
Flow rate:	125 to 391 gpm (475 to 1480 lpm)
Operating pressure:	10 to 50 psi (0.7 to 3.4 bar)
Max. temperature:	200°F (93°C)
Materials:	PTFE fluoropolymer resin
Inlet connection:	3" NPT or BSPT (F)
Optional accessories:	Strainers, recommended mesh size: 100 (150 micron) See page G2

**ADDITIONAL SIZES AVAILABLE**

Page D4 – 3/4, 1 and 2 in. conn.  
Page E4 – 3/8 and 1/2 in. conn.



**DIMENSIONS AND WEIGHT**

Model	Inlet Conn. in.	W in. (mm)	L in. (mm)	F (Flats) in. (mm)
27500	3	6.88 (174.6)	5.88 (149.2)	3.88 (98.4)

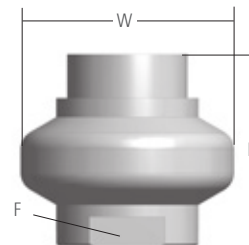

Additional sizes available:  
Page D4 – 3/4, 1 and 2 in. conn.  
Page E4 – 3/8 and 1/2 in. conn.

**IDEAL FOR CLEANING:**

- Broke chests
- Chemical tanks
- PCB washers
- Pharmaceutical tanks
- Process tanks



**TANKJET 27500 AND 27500-R TANK CLEANING NOZZLE  
FEATURES AND BENEFITS**

- With rotation driven by the reactionary force of the cleaning liquid, these nozzles provide excellent cleaning and rinsing and are especially well-suited for clean-in-place (CIP) systems
- Spray angles range from 180° to 360° and can be used to clean specific areas or the entire tank interior
- Made of corrosion- and chemical-resistant PTFE fluoropolymer resin, both models provide peak performance when used with debris-free liquid and deliver greater impact than static spray balls
- 27500-R nozzles with removeable spray heads, 1/2 in. and 3/4 in. inlet connections, are also available in carbon-filled PTFE for improved thermal characteristics and higher mechanical strength. See page D4 and E4
- ATEX-certified versions available



TankJet 27500-R  
tank cleaning nozzle,  
see page D4 and E4

TankJet 27500  
tank cleaning nozzle



**SPRAY COVERAGE**

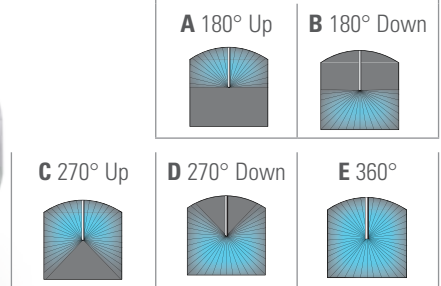

**MOUNTING  
OPTIONS**

Vertical	↑	↓
Horizontal	←	→
45° Up	↖	↗
45° Down	↘	↙

**SPECIFICATIONS**

TankJet 27500 Tank Cleaning Nozzles	
Max. tank diameter:	25 ft. (7.6 m)
Operating principle:	Fluid-driven reactionary force
Flow rate:	125 to 391 gpm (475 to 1480 lpm)
Operating pressure:	10 to 50 psi (0.7 to 3.4 bar)
Max. temperature:	200°F (93°C)
Materials:	PTFE fluoropolymer resin
Inlet connection:	3" NPT or BSPT (F)
Optional accessories:	Strainers, recommended mesh size: 100 (150 micron) See page G2

**ADDITIONAL SIZES AVAILABLE**

Page D4 – 3/4, 1 and 2 in. conn.  
Page E4 – 3/8 and 1/2 in. conn.



**DIMENSIONS AND WEIGHT**

Model	Inlet Conn. in.	W in. (mm)	L in. (mm)	F (Flats) in. (mm)
27500	3	6.88 (174.6)	5.88 (149.2)	3.88 (98.4)

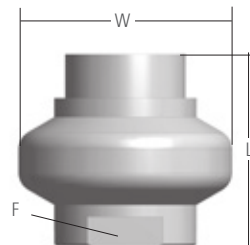

Additional sizes available:  
Page D4 – 3/4, 1 and 2 in. conn.  
Page E4 – 3/8 and 1/2 in. conn.

**IDEAL FOR CLEANING:**

- Broke chests
- Chemical tanks
- PCB washers
- Pharmaceutical tanks
- Process tanks



**TANKJET 27500 AND 27500-R  
TANK CLEANING NOZZLE  
FEATURES AND BENEFITS**

- With rotation driven by the reactionary force of the cleaning liquid, these rotating nozzles provide excellent cleaning and rinsing and are especially well-suited to clean-in-place (CIP) systems
- Spray angles range from 180° to 360° and can be used to clean specific areas or the entire tank interior
- Made of corrosion- and chemical-resistant PTFE fluoropolymer resin, both models offer peak performance when used with debris-free liquid and deliver greater impact than static spray balls
- The rotating spray heads on 27500-R nozzles can be easily removed from the body for inspection and maintenance
- 27500-R nozzles with 1/2 in. and 3/4 in. inlet connections are also available in carbon-filled PTFE for improved thermal characteristics and higher mechanical strength
- ATEX-certified versions available



TankJet 27500  
tank cleaning nozzle



TankJet 27500-R  
tank cleaning nozzle



**SPRAY COVERAGE**

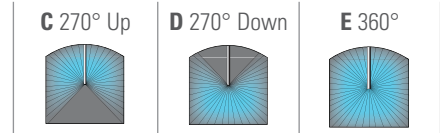
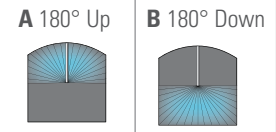

**MOUNTING  
OPTIONS**

Vertical	↑	↓
Horizontal	←	→
45° Up	↖	↗
45° Down	↘	↙

**SPECIFICATIONS**

TankJet Tank Cleaning Nozzle	27500	27500-R
Max. tank diameter:	15 to 20 ft. (4.3 to 6.0 m)	15 to 20 ft. (4.3 to 6.0 m)
Operating principle:	Fluid-driven reactionary force	Fluid-driven reactionary force
Flow rate:	9.0 to 224 gpm (34 to 850 lpm)	9.0 to 224 gpm (34 to 850 lpm)
Operating pressure:	10.0 to 50 psi (0.7 to 3.4 bar)	10.0 to 50 psi (0.7 to 3.4 bar)
Max. temperature:	200°F (93°C)	200°F (93°C)
Materials:	PTFE fluoropolymer resin or CTEF	PTFE fluoropolymer resin or CTEF
Inlet connection:	3/4" to 2" NPT or BSPT (F)	3/4" or 1" NPT or BSPT (F)
Optional accessories:	Strainers, recommended mesh size: 100 (150 micron) See page G2	

**IDEAL FOR CLEANING:**

- Broke chests
- Chemical tanks
- PCB washers
- Pharmaceutical tanks
- Process tanks

For lances, mounting kits, adapters and more,  
see page G6

**DIMENSIONS AND WEIGHT**

Model	Inlet Conn. in.	D (Dia.) in. (mm)	L in. (mm)	F (Flats) in. (mm)
27500, 27500-R	3/4	2.25 (57.2)	2.63 (66.6)	1.31 (33.3)
27500, 27500-R	1	2.75 (69.8)	3 (76.2)	1.63 (45.3)
27500	2	4.88 (123.8)	4.38 (111)	2.75 (69.8)

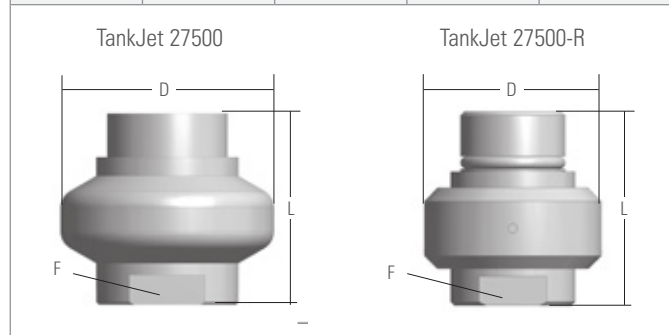

Additional sizes available:  
Page C16 – 3 in. conn.  
Page E4 – 3/8 and 1/2 in. conn.



PERFORMANCE DATA

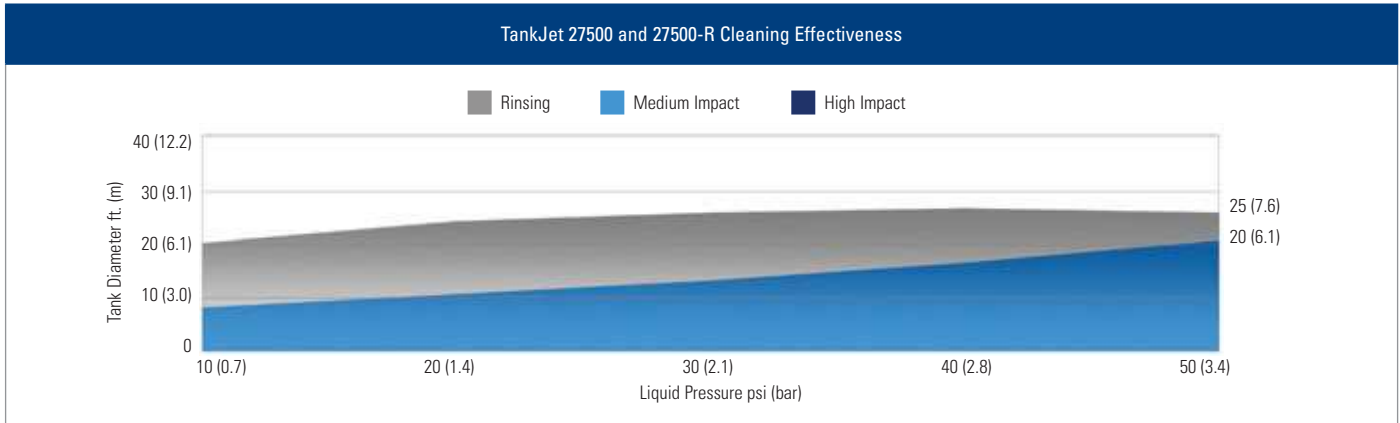

Model		Inlet Conn.	Capacity Size	Orifice Dia. in. (mm)	Liquid Flow Capacity gpm (lpm)					Max. Tank Dia. ft. (m)
27500	27500-R				10 psi (0.7 bar)	20 psi (1.4 bar)	30 psi (2.1 bar)	40 psi (2.8 bar)	50 psi (3.4 bar)	
•	•	3/4	18	0.094 (2.4)	9.0 (34)	12.7 (48)	15.6 (59)	18 (68)	20 (76)	15 (4.3)
•	•		32	0.156 (4.0)	16.0 (61)	23 (89)	28 (103)	32 (126)	36 (136)	15 (4.3)
•	•		46	0.234 (6.0)	23 (87)	33 (130)	40 (148)	46 (182)	51 (196)	15 (4.3)
•	•	1	50	0.156 (4.0)	25 (95)	35 (140)	43 (161)	50 (197)	56 (215)	18 (5.5)
•	•		70	0.219 (5.6)	35 (133)	49 (195)	61 (225)	70 (275)	78 (300)	18 (5.5)
•	•		90	0.297 (7.5)	45 (172)	64 (250)	78 (290)	90 (355)	101 (385)	18 (5.5)
•	•	2	100	0.234 (6.0)	50 (191)	71 (280)	87 (320)	100 (395)	112 (425)	20 (6.0)
•	•		125	0.266 (6.7)	63 (240)	88 (350)	108 (400)	125 (495)	140 (530)	20 (6.0)
•	•		150	0.313 (7.9)	75 (285)	106 (420)	130 (480)	150 (590)	168 (640)	20 (6.0)
•	•		175	0.375 (9.5)	88 (335)	124 (490)	152 (560)	175 (690)	196 (745)	20 (6.0)
•	•		200	0.422 (10.7)	100 (380)	141 (560)	173 (645)	200 (790)	224 (850)	20 (6.0)

Suggested optimum operating range: 20 to 40 psi (1.5 to 2.8 bar).

**ADDITIONAL SIZES AVAILABLE**

**Page C16 – 3 in. conn.**  
**Page E4 – 3/8 and 1/2 in. conn.**

ORDERING INFORMATION

TANKJET 27500 AND 27500-R TANK CLEANING NOZZLES

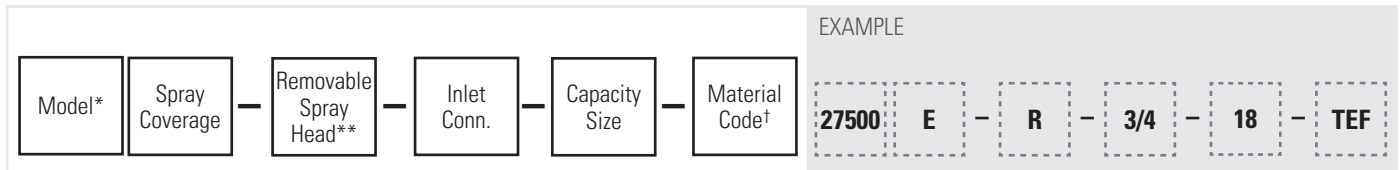

\*Add B prior to the nozzle type for BSPT connections.  
\*\*Leave blank for standard version.  
†Indicate CTEF for carbon-filled PTFE on 3/4 in. inlet connections for 27500-R.



**TANKJET 27500 AND 27500-R TANK CLEANING NOZZLE FEATURES AND BENEFITS**

- With rotation driven by the reactionary force of the cleaning liquid, these rotating nozzles provide excellent cleaning and rinsing and are especially well-suited to clean-in-place (CIP) systems
- Spray angles range from 180° to 360° and can be used to clean specific areas or the entire tank interior
- Made of corrosion- and chemical-resistant PTFE fluoropolymer resin, both models provide peak performance when used with debris-free liquid and deliver greater impact than static spray balls
- The rotating spray heads on 27500-R nozzles can be easily removed from the body for inspection and maintenance
- 27500-R nozzles with removeable spray heads, 1/2 in. and 3/4 in. inlet connections, are also available in carbon-filled PTFE for improved thermal characteristics and higher mechanical strength.
- ATEX-certified versions available



TankJet 27500 tank cleaning nozzle

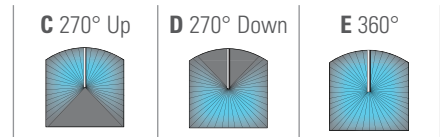
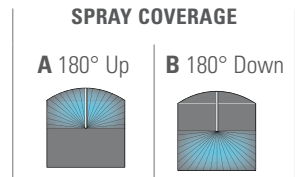

**MOUNTING OPTIONS**

Vertical	↑	↓
Horizontal	←	→
45° Up	↖	↗
45° Down	↘	↙



TankJet 27500-R tank cleaning nozzle

**SPECIFICATIONS**

TankJet 27500 and 27500-R Tank Cleaning Nozzles	
Max. tank diameter:	10 ft. (3.0 m)
Operating principle:	Fluid-driven reactionary force
Flow rate:	2.6 to 8.9 gpm (9.8 to 34 lpm)
Operating pressure:	10 to 50 psi (0.7 to 3.4 bar)
Max. temperature:	200°F (93°C)
Materials:	PTFE fluoropolymer resin or CTEF
Inlet connection:	3/8" or 1/2" NPT or BSPT (F)
Optional accessories:	Strainers, recommended mesh size: 100 (150 micron) See page G2

**DIMENSIONS AND WEIGHT**

Model	Inlet Conn. in.	D in. (mm)	L in. (mm)	F (Flats) in. (mm)
27500-R	3/8	1.69 (43)	2.0 (51)	0.94 (23.8)
27500, 27500-R	1/2	1.94 (49.2)	2.38 (60.3)	1.13 (28.6)

Additional sizes available:  
Page C16 – 3 in. conn.  
Page D4 – 3/4, 1 and 2 in. conn.

**IDEAL FOR CLEANING:**

- Broke chests
- Chemical tanks
- PCB washers
- Pharmaceutical tanks
- Process tanks

**PERFORMANCE DATA**

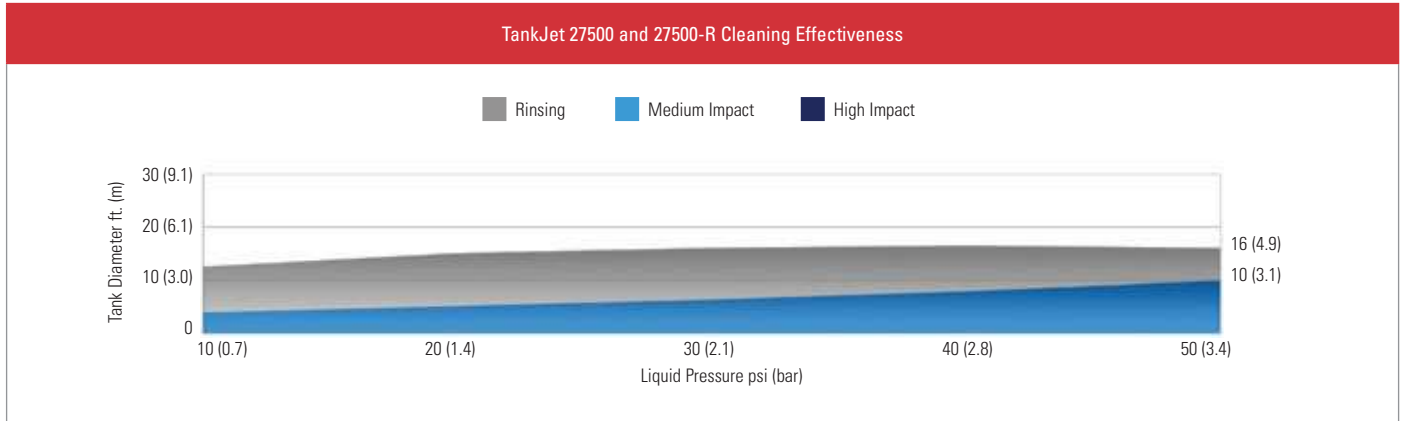

Model		Inlet Conn. Size in.	Capacity Size	Orifice Dia. in. (mm)	Liquid Flow Capacity gpm (lpm)*					Max. Tank Dia. ft. (m)
27500	27500-R				10 psi (0.7 bar)	20 psi (1.4 bar)	30 psi (2.1 bar)	40 psi (2.8 bar)	50 psi (3.4 bar)	
	•	3/8	5	0.052 (1.3)	2.6 (9.8)	3.8 (14.4)	4.7 (17.8)	5.4 (20.4)	6.3 (23.8)	10 (3.0)
	•		7	3/32 (2.4)	3.7 (14.0)	5.3 (20)	6.2 (23.5)	7.4 (28)	8.2 (31)	10 (3.0)
•	•*	1/2	8	3/32 (2.4)	4.0 (15.3)	5.7 (22)	6.9 (26)	8.0 (30)	8.9 (34)	10 (3.0)

\*Suggested optimum operating range: 20 to 40 psi (1.5 to 2.8 bar).

**ADDITIONAL SIZES AVAILABLE**

**Page C16 – 3 in. conn.**  
**Page D4 – 3/4, 1 and 2 in. conn.**

**ORDERING INFORMATION**

**TANKJET 27500 AND 27500-R TANK CLEANING NOZZLES**

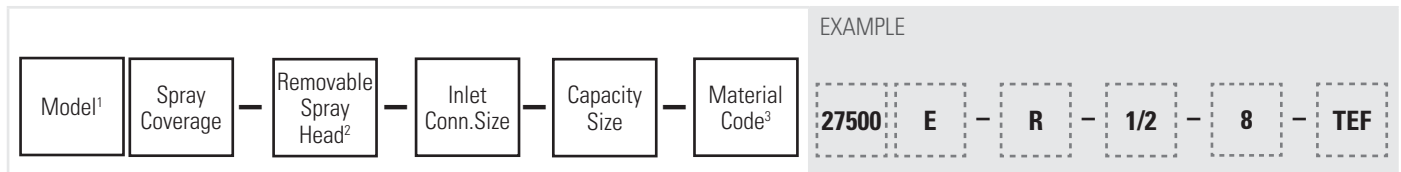

<sup>1</sup>Add B prior to the model for BSPT connections.

<sup>2</sup>Leave blank for standard version.

<sup>3</sup>Indicate CTEF for carbon-filled PTFE on 1/2 in. inlet connections for 27500-R.

**For lances, mounting kits, adapters and more,  
see page G6**